

MİMARİ KATALOG ARCHITECTURAL CATALOGUE

Alüminyum Kapı Pencere ve Giydirme Cephe Sistemleri
Aluminium Window Doors and Facade Systems

SKY 65

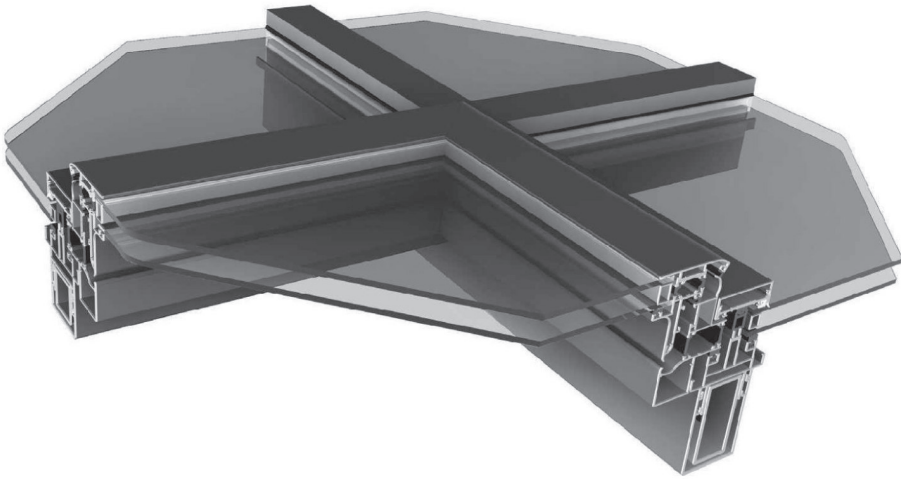

MİMARİ KATALOG ARCHITECTURAL CATALOGUE

Alüminyum Kapı Pencere ve Giydirme Cephe Sistemleri
Aluminium Window Doors and Facade Systems

SKY65

PROFİLLER

PROFILES

01

02

03

04

05

06

KOD / CODE	AĞIRLIK (kg/m) / WEIGHT	Jxx cm4	Jyy cm4	Wx cm3	Wy cm3	L m	
R50 M 16	1,972	40,203	21,856	----	----	6	
R50 T 11	2,085	44,694	22,469	----	----	6	

01

02

03

04

05

06

R50 M 16

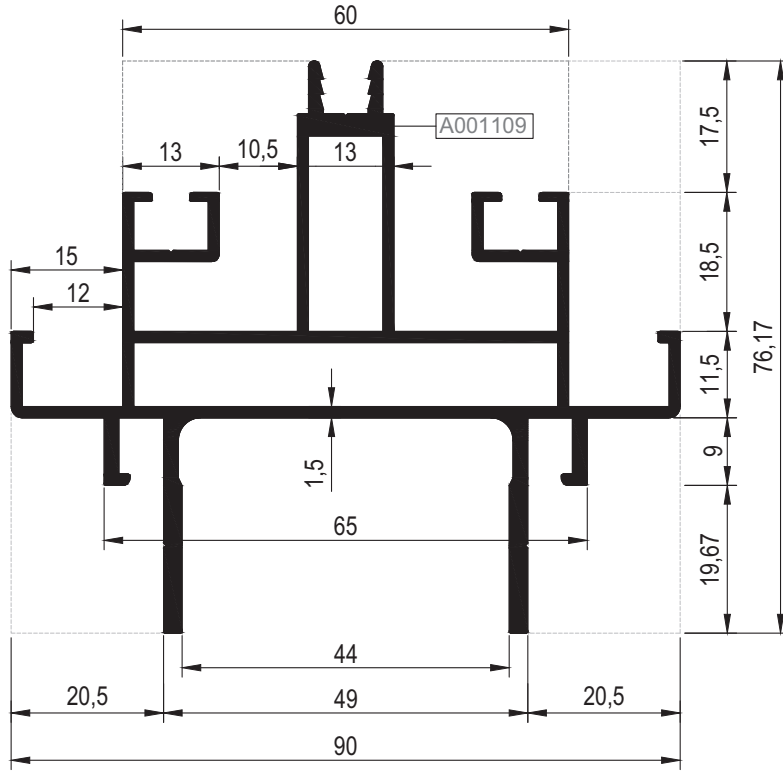

R50 T 11

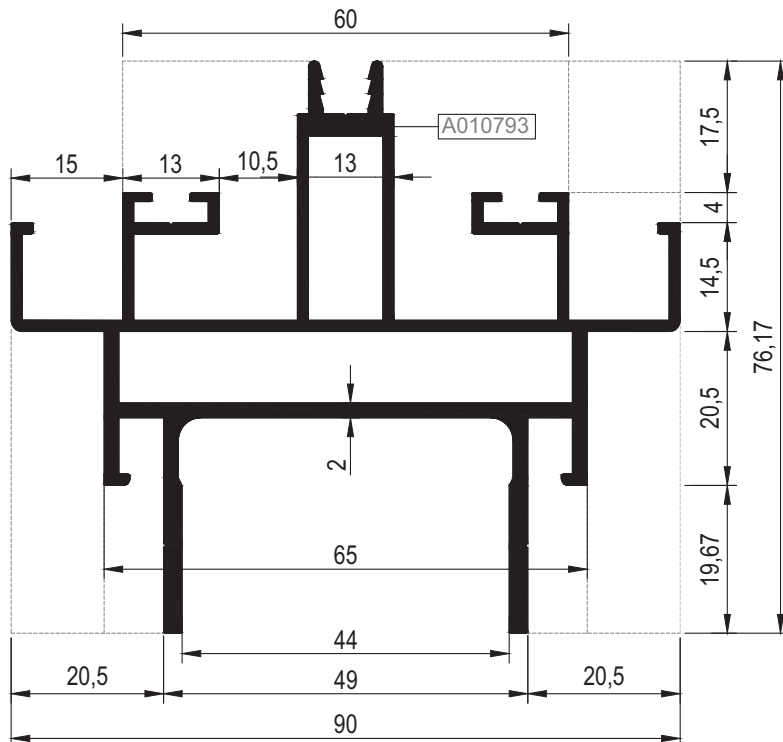

KOD / CODE	AĞIRLIK (kg/m) / WEIGHT	Jxx cm4	Jyy cm4	Wx cm3	Wy cm3	L m	
R50 T 10	2,077	47,190	25,938	----	----	6	
R50 T 09	1,101	25,071	3,889	----	----	6	

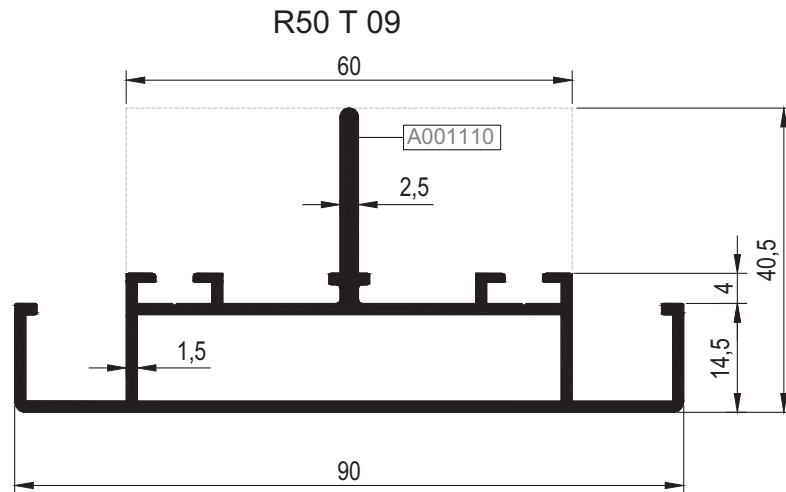
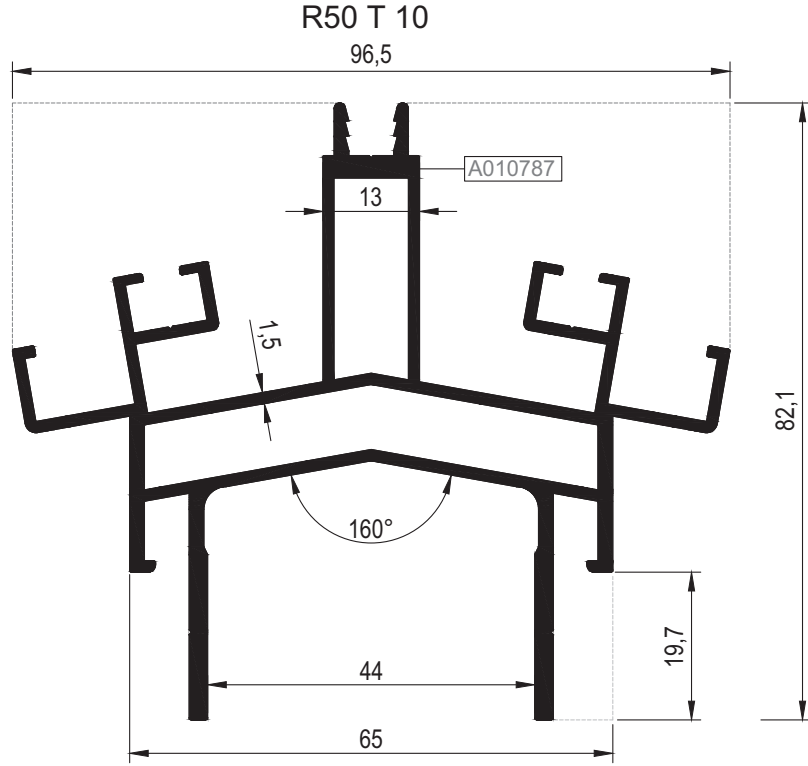

01

02

03

04

05

06

KOD / CODE	AĞIRLIK (kg/m) / WEIGHT	Jxx cm ⁴	Jyy cm ⁴	Wx cm ³	Wy cm ³	L m	
R50 M 10	2,565	21,713	86,773	----	----	6	
R50 T 07	1,052	9,560	4,362	----	----	6	

01

02

03

04

05

06

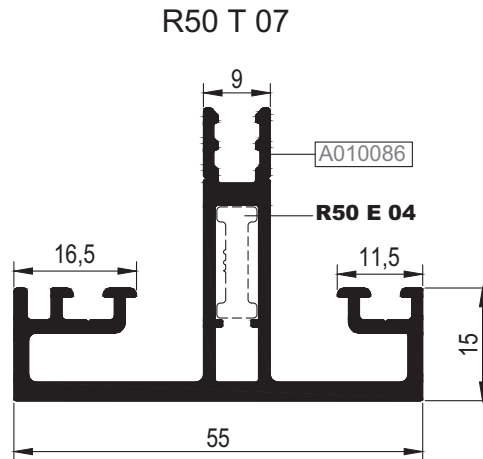
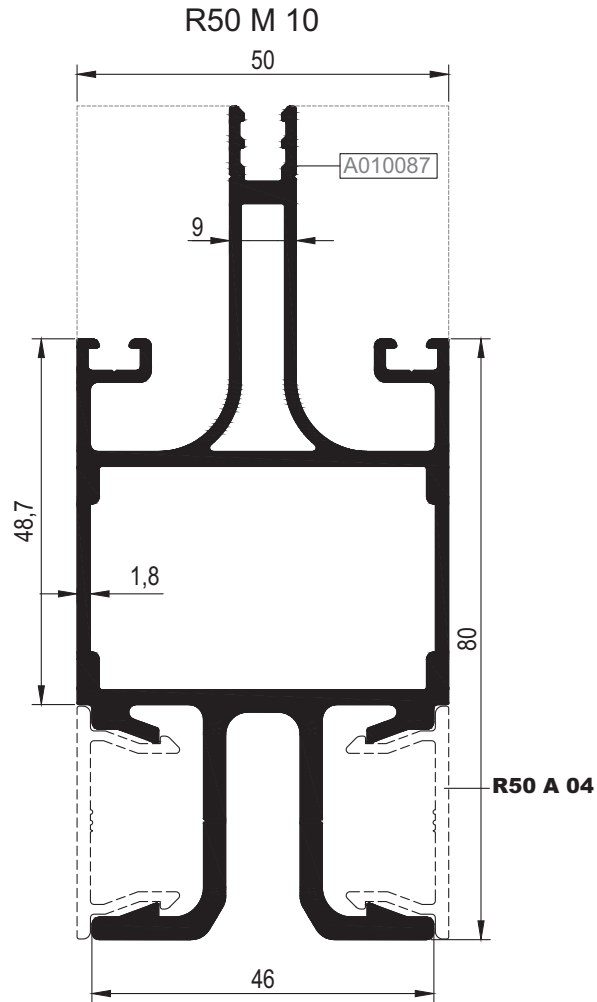

KOD / CODE	AĞIRLIK (kg/m) / WEIGHT	L m	KOD / CODE	AĞIRLIK (kg/m) / WEIGHT	L m
R50 P 33	2,997	6			
K50 P 18	2,313	6			

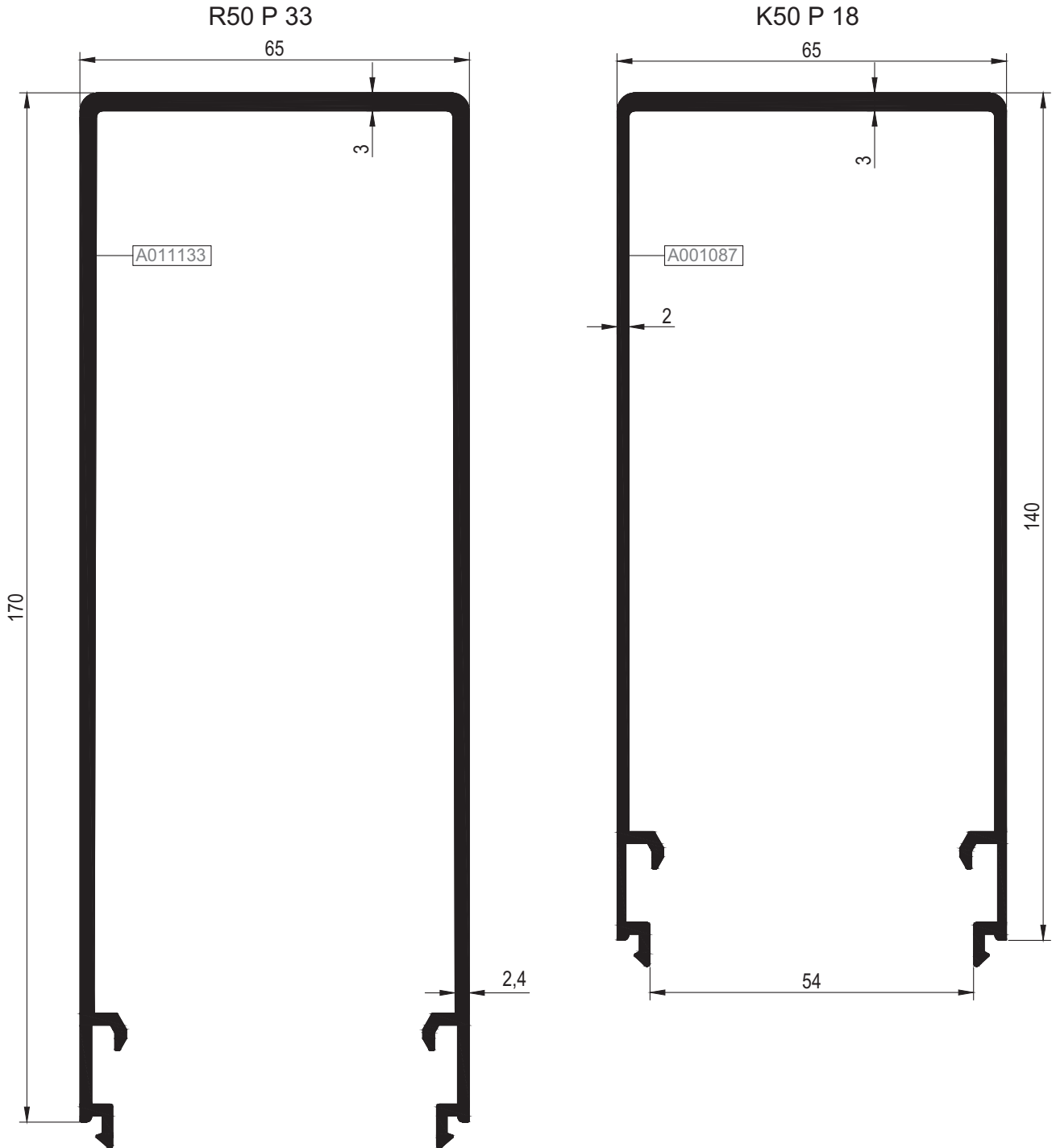
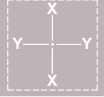

01

02

03

04

05

06

KOD / CODE	AĞIRLIK (kg/m) / WEIGHT	L m	KOD / CODE	AĞIRLIK (kg/m) / WEIGHT	L m
K50 P 19	1,336	6			
K50 P 20	0,901	6			



01

02

03

04

05

06

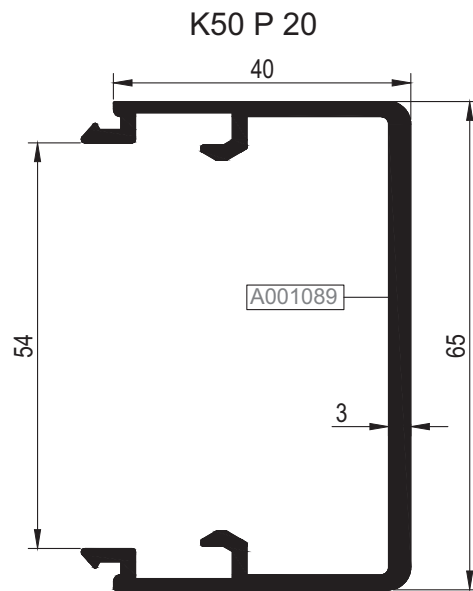
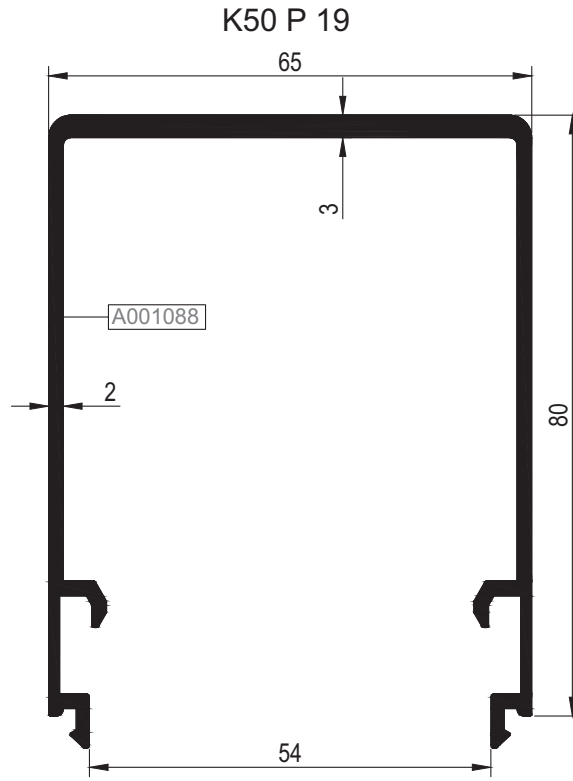

KOD / CODE	AĞIRLIK (kg/m) / WEIGHT	L m	KOD / CODE	AĞIRLIK (kg/m) / WEIGHT	L m
R50 P 05	0,566	6	R50 A 04	0,245	6
R50 P 04	0,455	6	R50 E 04	0,146	6
R50 P 21	0,872	6	R50 S 03	0,362	6
R50 P 22	0,580	6			

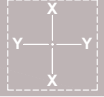

R50 P 05

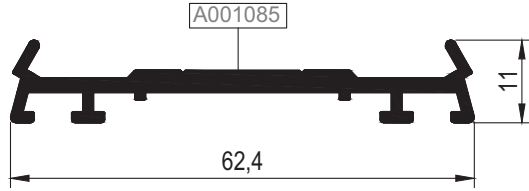

R50 P 04

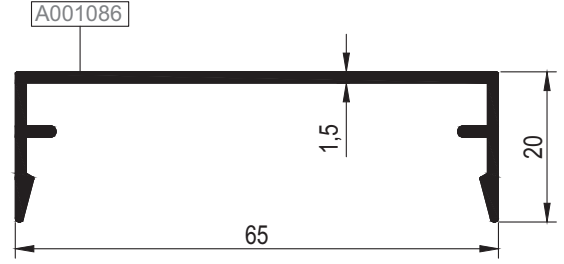

R50 P 21

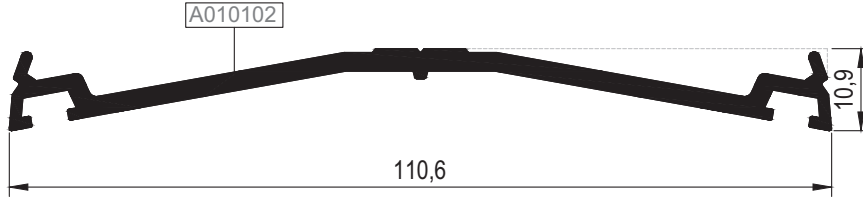

R50 P 22

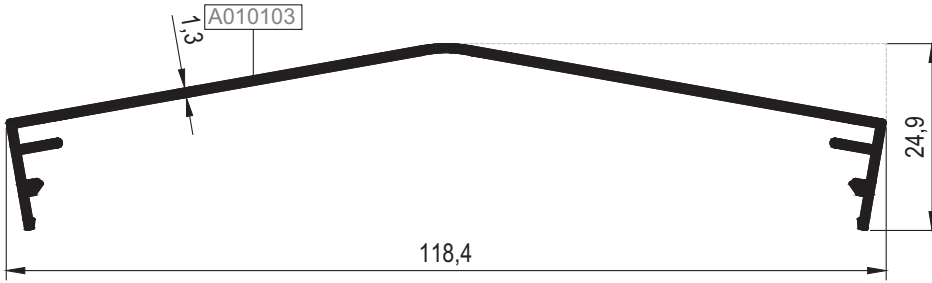

R50 P 43

R50 P 44

R50 A 04

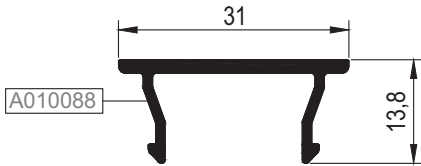

R50 E 04

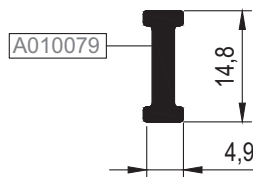

R50 S 03

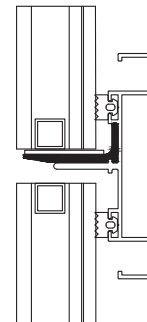
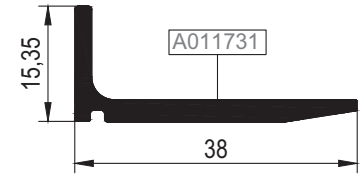

Ölçek/Scale: 1/2

01

02

03

04

05

06

KOD / CODE	AĞIRLIK (kg/m) / WEIGHT	Jxx cm ⁴	Jyy cm ⁴	Wx cm ³	Wy cm ³	L m	
AR50M22	1,728	----	----	----	----	6	
AR50M23	1,660	----	----	----	----	6	

AR50M22

AR50M23

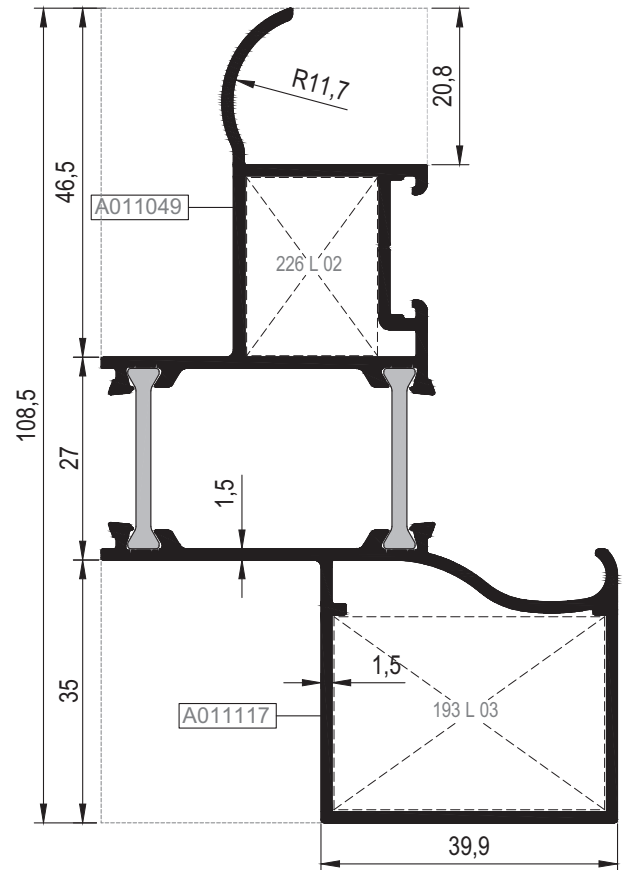
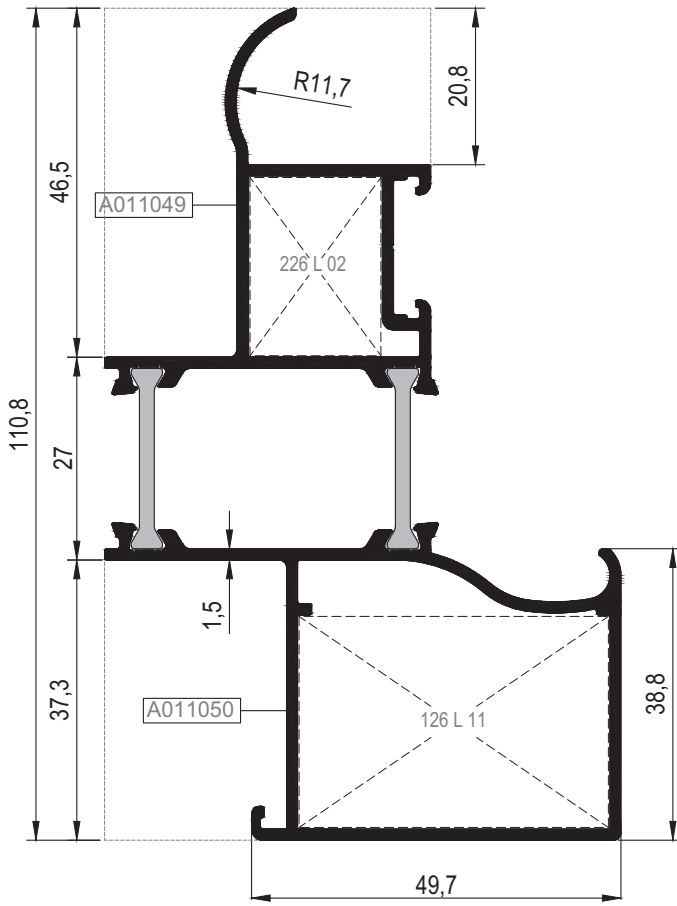

Nr	KÖŞE BAĞLANTI PROFİLİ PROFİL KOD NUMARASI		KÖŞE BAĞLANTI PROFİLİ PARÇA KOD NUMARASI		KESİM ÖLÇÜSÜ
AR50M22	A011049	A002020 (25 L 02)		226 L 02	23,8 mm
	A011050	A002126 (25 L 11)		126 L 11	28,1 mm
AR50M23	A011049	A002020 (25 L 02)		226 L 02	23,8 mm
	A011117	A002021 (25 L 03)		193 L 03	25,9 mm

KOD / CODE	AĞIRLIK (kg/m) / WEIGHT	Jxx cm4	Jyy cm4	Wx cm3	Wy cm3	L m	
AR50V20	1,216	----	----	----	----	6	
R50 R 12	0,643	----	----	----	----	6	

AR50V20

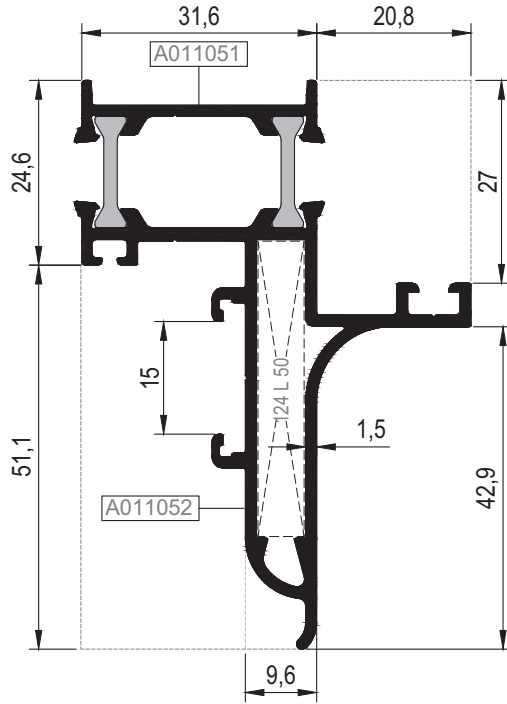

R50 R 12

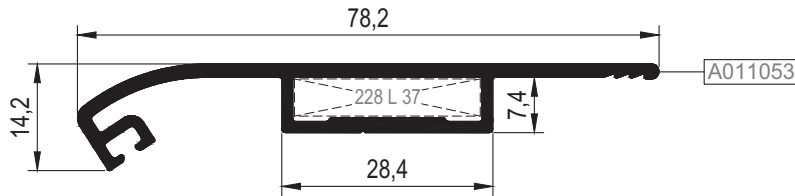

Nr	KÖŞE BAĞLANTI PROFİLİ PROFİL KOD NUMARASI	KÖŞE BAĞLANTI PROFİLİ PARÇA KOD NUMARASI	KESİM ÖLÇÜSÜ
AR50V20	A011052	A010838 (25 L 50)	39,3 mm
R50 R 12	A011053	A002398 (25 L 37)	5,1 mm

PROFİL KODU (PROFILE CODE)	25 L 02	25 L 03	25 L 11	25 L 37
FABRİKA KODU(FACTORY CODE)	A002020	A002021	A002126	A002398
AĞIRLIK (WEIGHT)	4,943 kg/m	4,315 kg/m	6,733 kg/m	7,971 kg/m
ÇİZİM (DRAWING)				

PROFİL KODU (PROFILE CODE)	25 L 50			
FABRİKA KODU(FACTORY CODE)	A010838			
AĞIRLIK (WEIGHT)	1,748 kg/m			
ÇİZİM (DRAWING)				

Nr		KESİM ÖLÇÜSÜ CUTTING SIZE	AKS. KODU ACS. CODE
AR50M22	A011049 25 L 02 (A002020)	23,8 mm	226 L 02
	A011050 25 L 11 (A002126)	28,1 mm	126 L 11
AR50M23	A011049 25 L 02 (A002020)	23,8 mm	226 L 02
	A011117 25 L 03 (A002021)	25,9 mm	193 L 03
AR50V20	A011052 25 L 50 (A010838)	39,3 mm	124 L 50
R50 R 12	A011053 25 L 37 (A002398)	5,1 mm	228 L 37

STOKTA BULUNAN SİSTEM PROFİLLERİNİN LİSTESİ
(LIST OF SYSTEM PROFILES IN STOCK)

Nr	MIN. SİPARİŞ MİKTARI MIN. ORDER QUANTITY
R50 M 16	A001109 75 kg
R50 T 11	A010793 75 kg
R50 P 04	A001086 75 kg
R50 P 05	A001085 75 kg
K50 P 19	A001088 75 kg

* STOKTA BULUNMAYAN TÜM PROFİLLER İÇİN MİNİMUM SİPARİŞ MİKTARI 300 KG'DİR.
MINIMUM ORDER QUANTITY FOR ALL THE PROFILES THAT ARE NOT IN STOCK IS 300 KG.

MİMARİ KATALOG ARCHITECTURAL CATALOGUE

Alüminyum Kapı Pencere ve Giydirme Cephe Sistemleri
Aluminium Window Doors and Facade Systems

SKY65

DETAYLAR

DETAILS

01

02

03

04

05

06

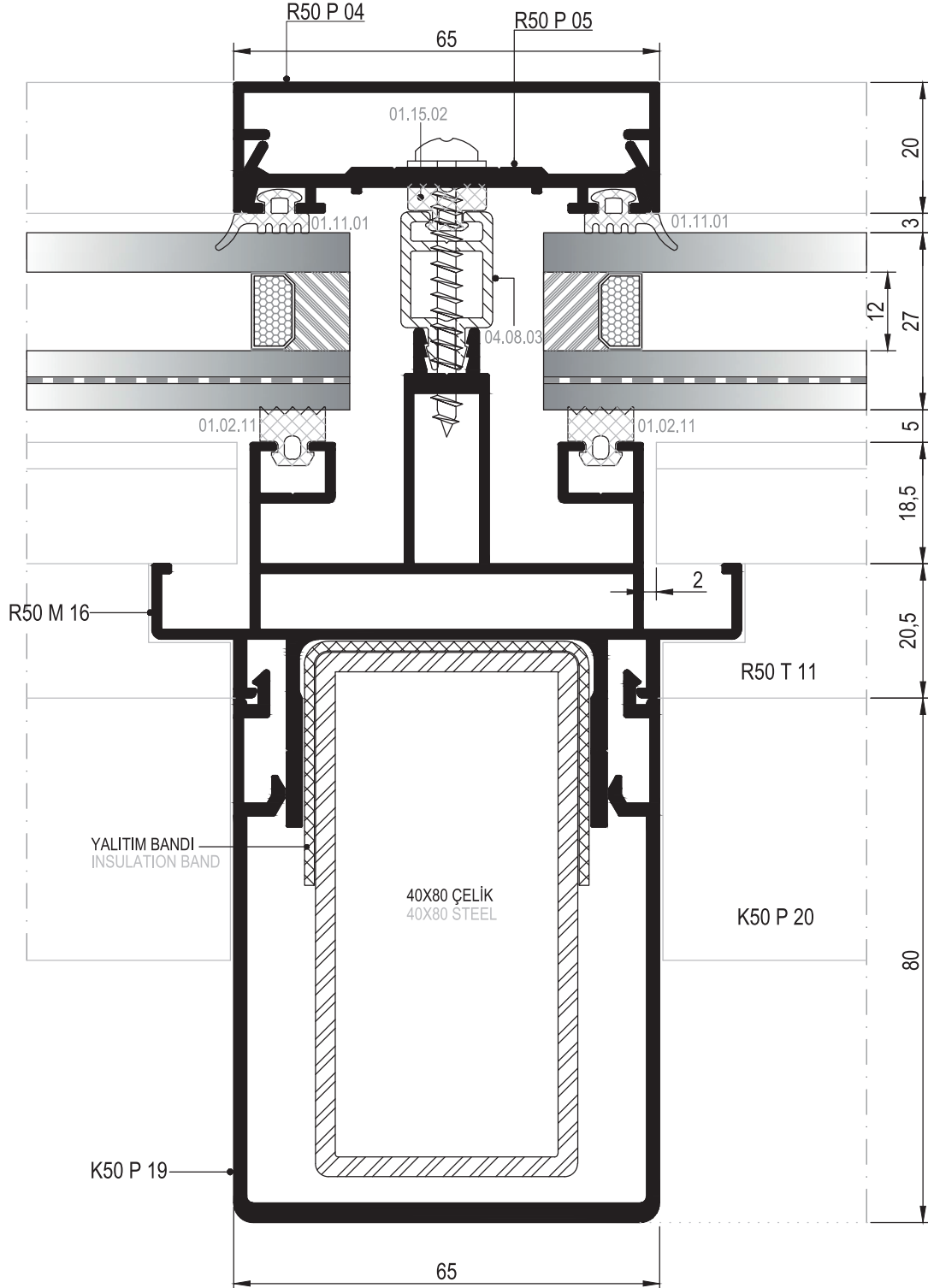
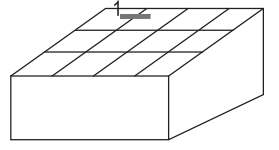

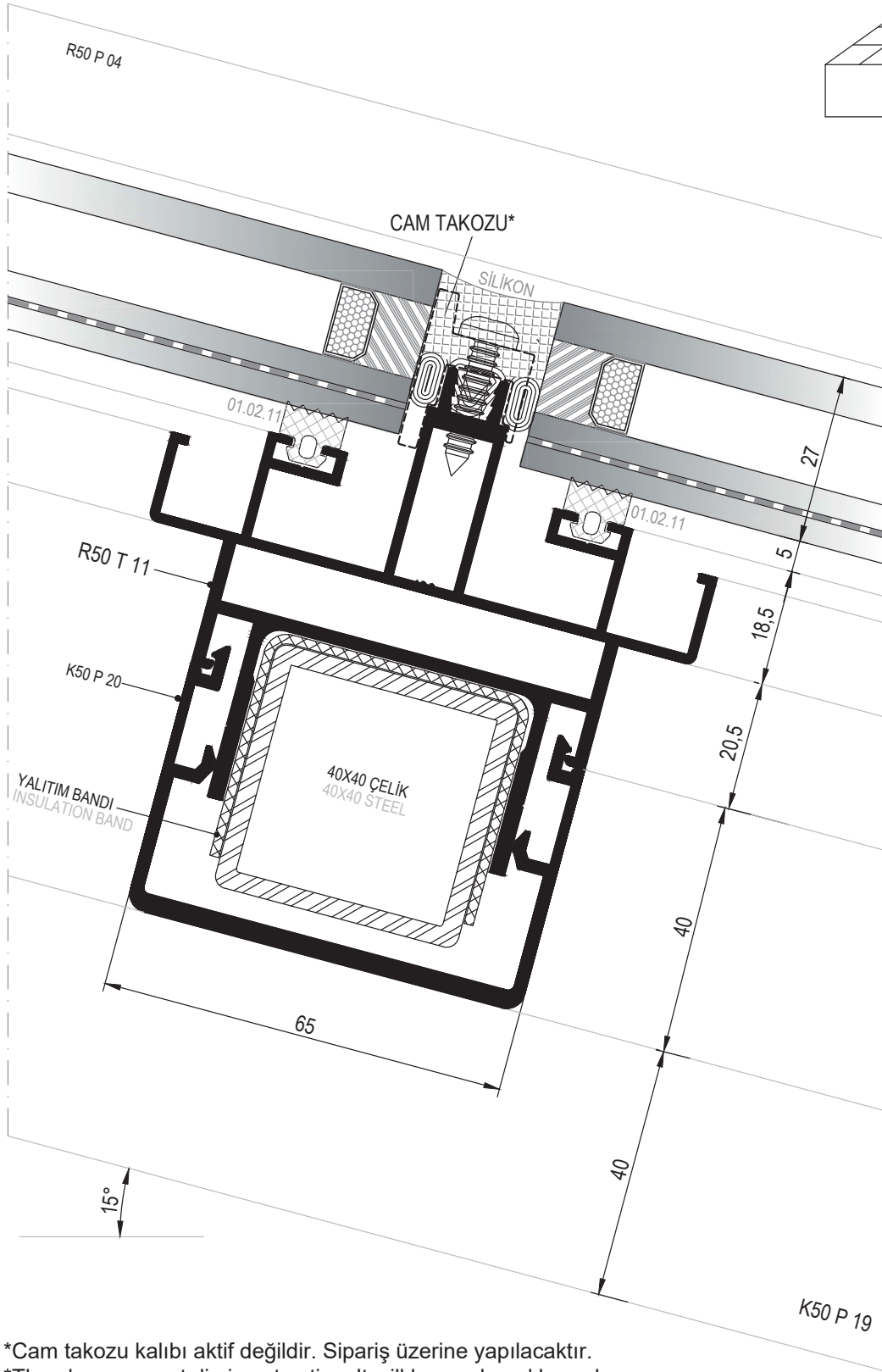

*Cam takozu kalıbı aktif değildir. Sipariş üzerine yapılacaktır.

*The glass support die is not active. It will be produced by order.

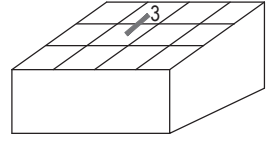

01

02

03

04

05

06

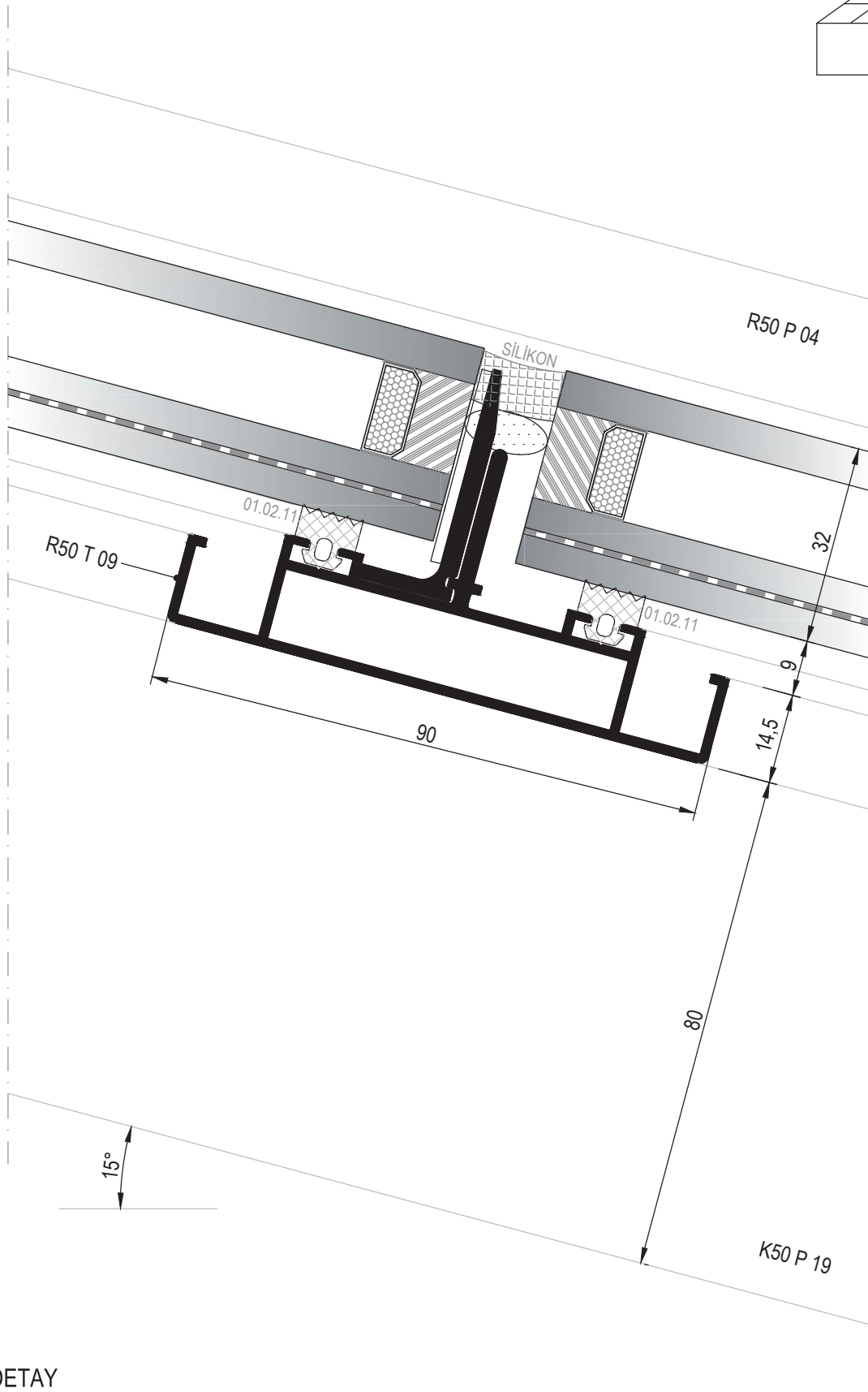

③ DETAY
DETAIL

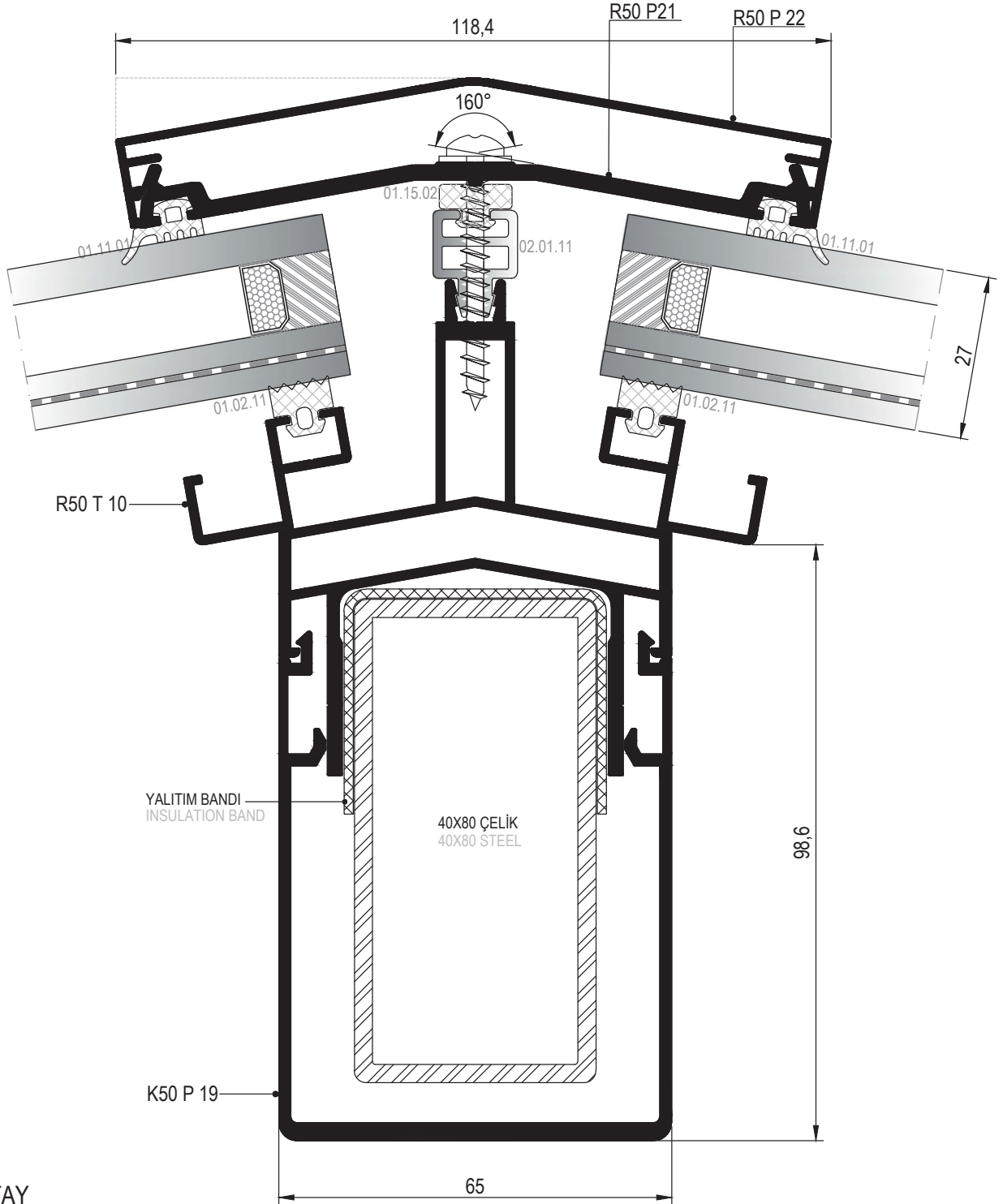
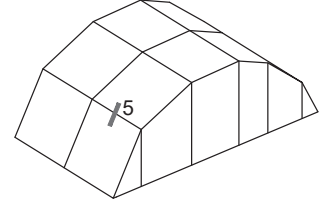

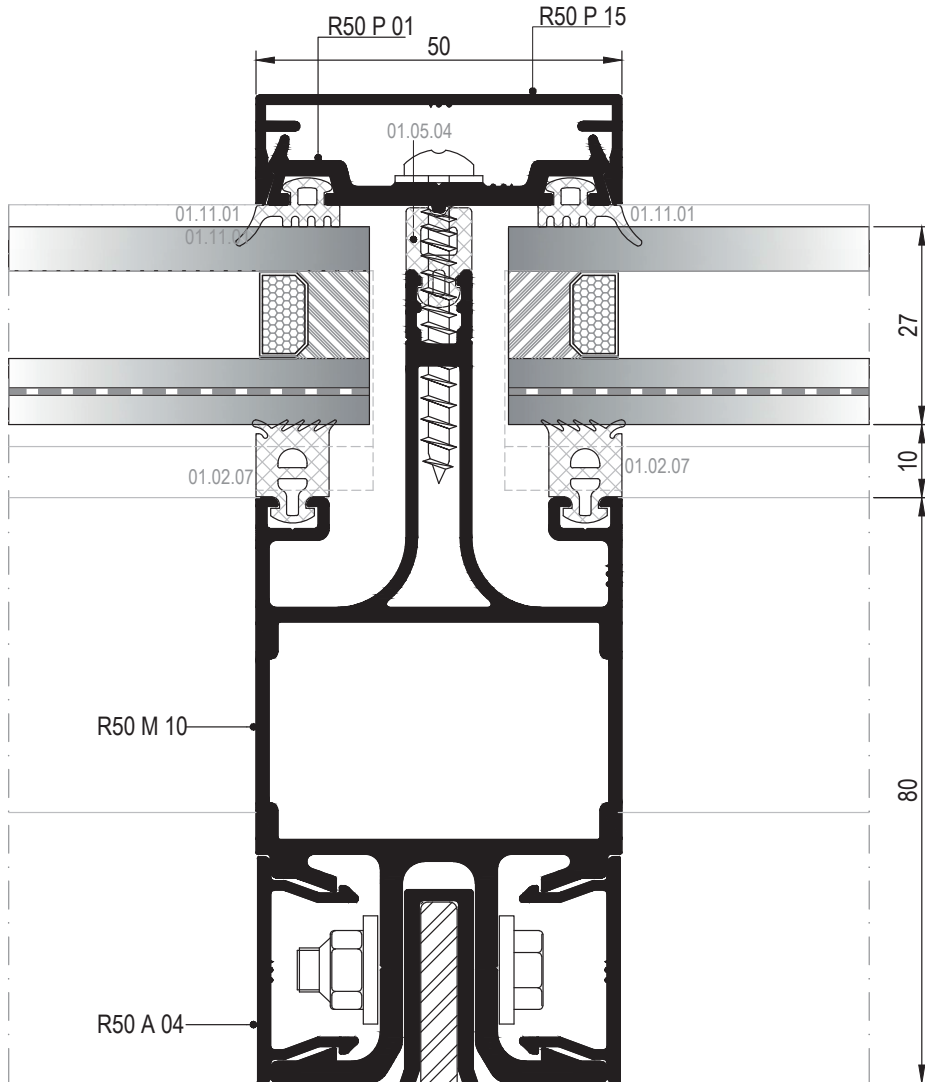
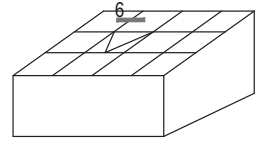

⑥ DETAY
DETAIL

01

02

03

04

05

06

01

02

03

04

05

06

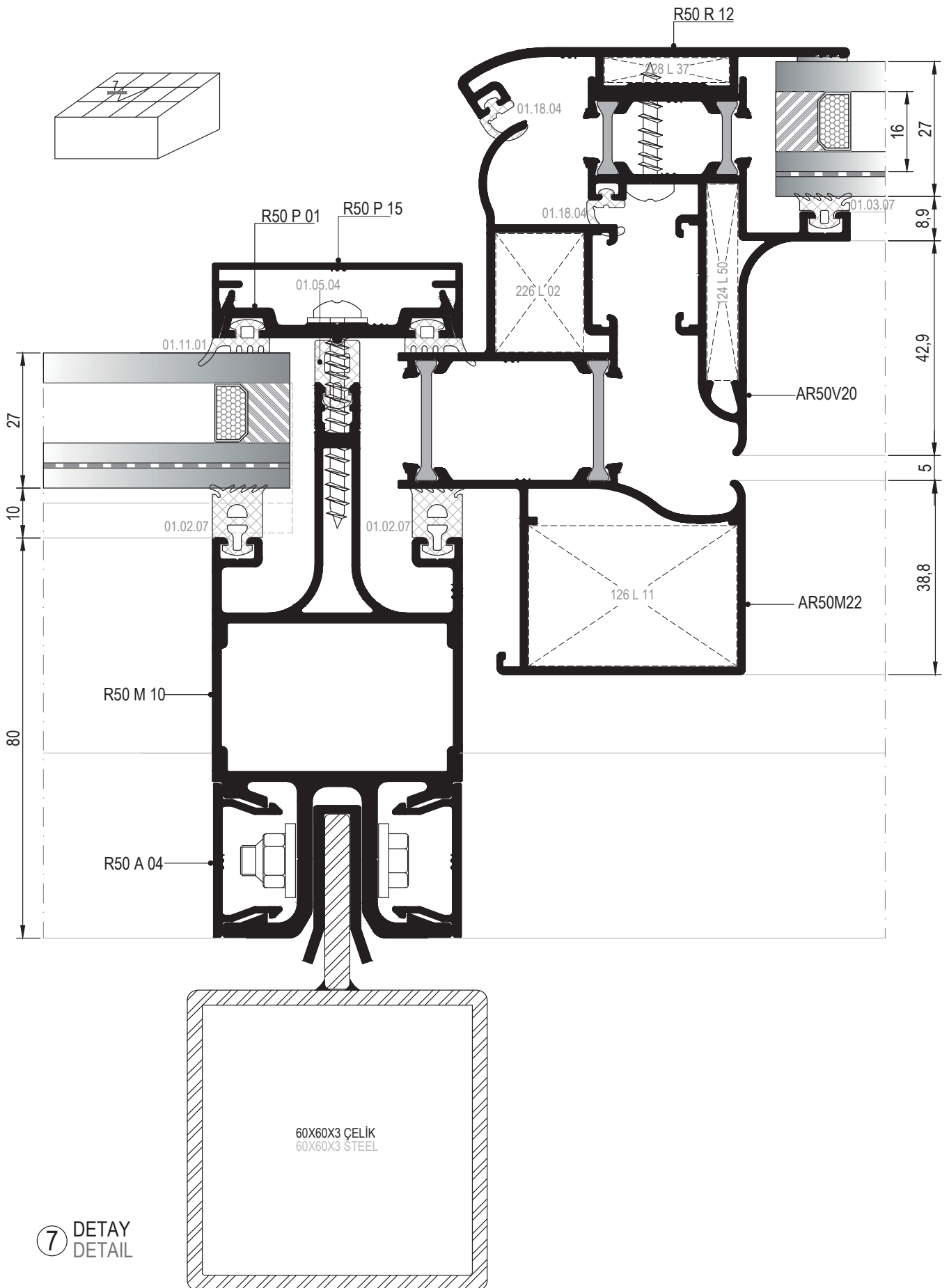

7 DETAY
DETAIL

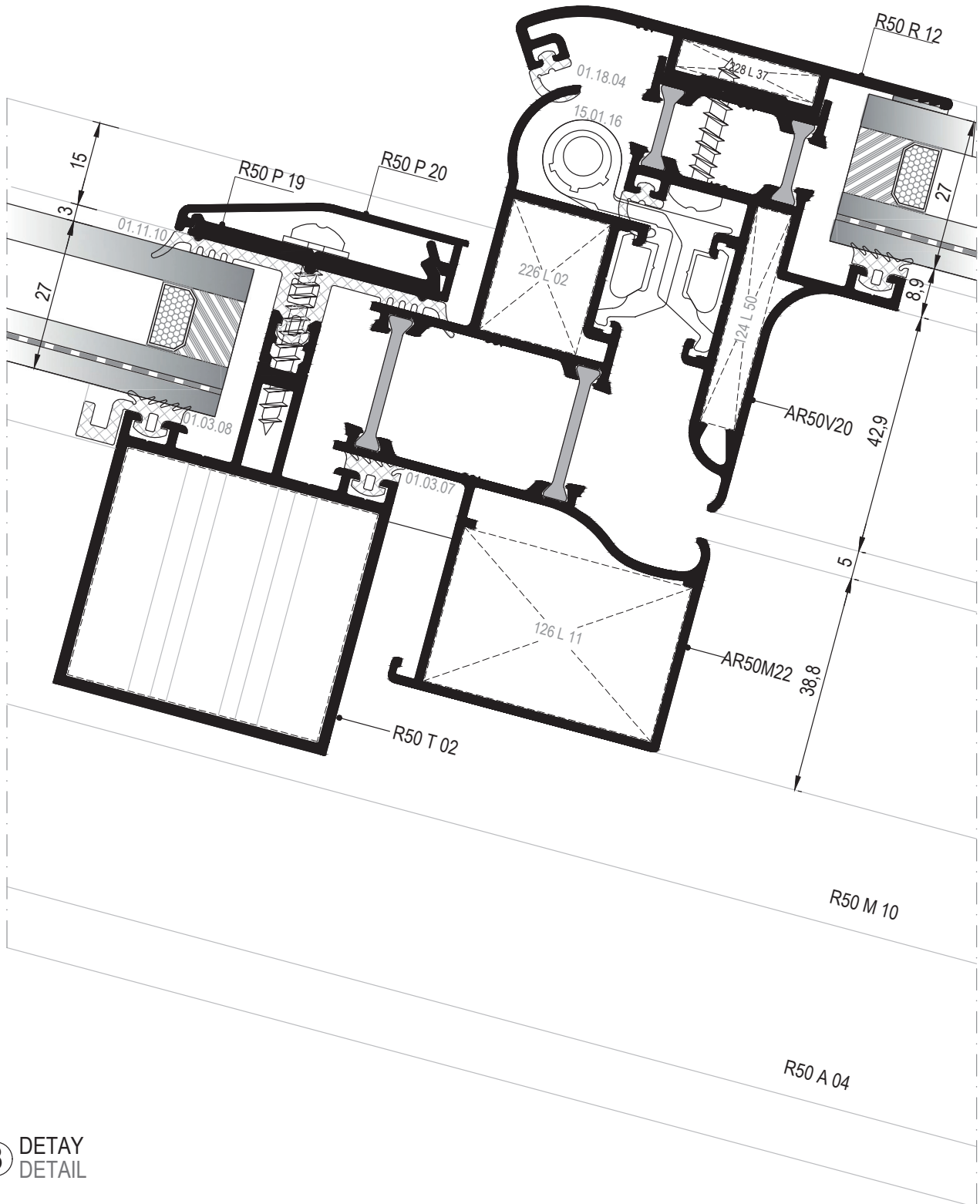
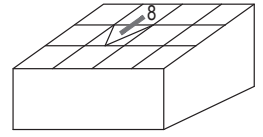

- 01
- 02
- 03
- 04
- 05
- 06

8 DETAY
DETAIL

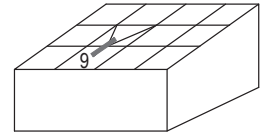

01

02

03

04

05

06

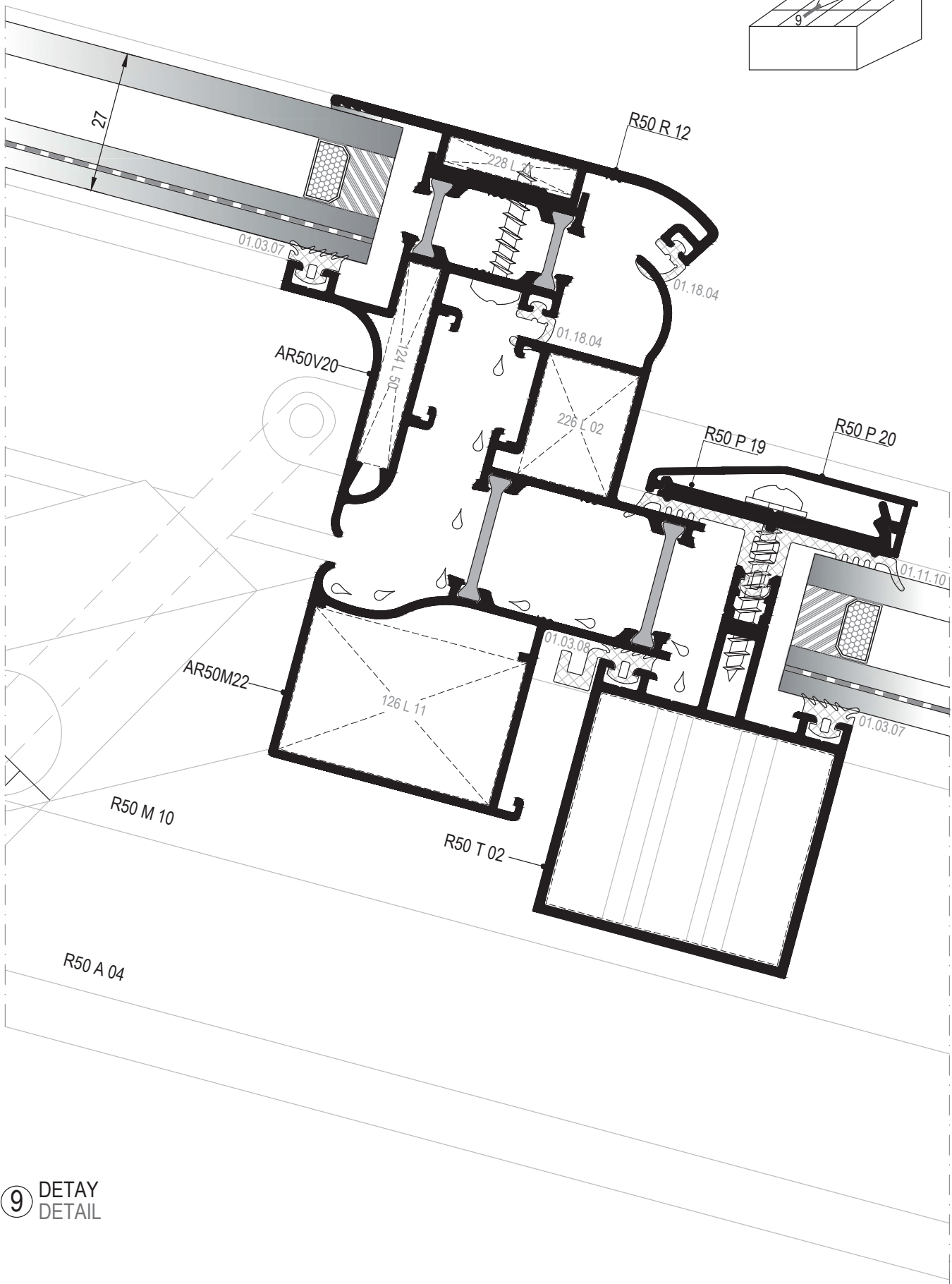

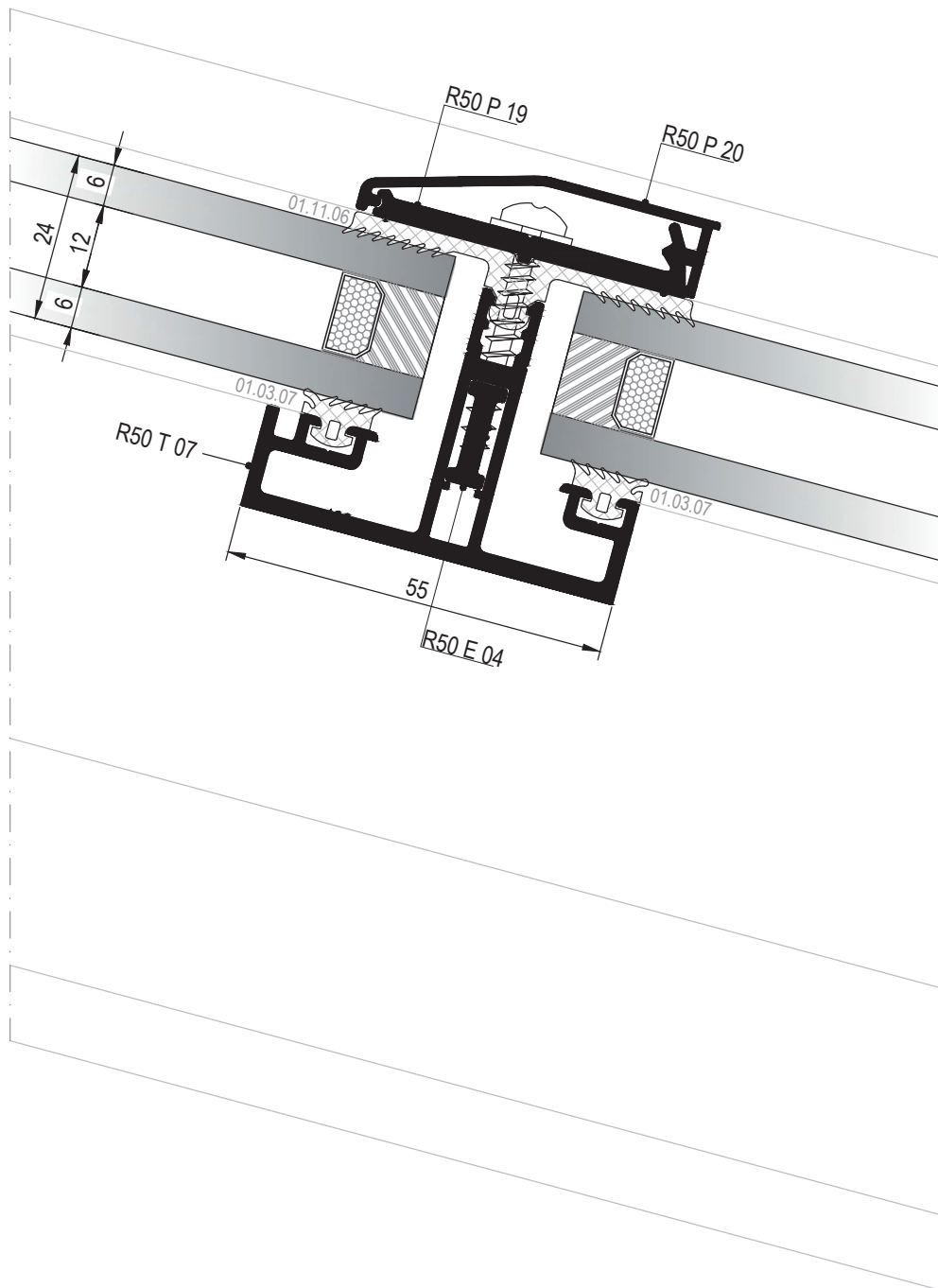
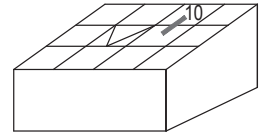

01

02

03

04

05

06

MİMARİ KATALOG ARCHITECTURAL CATALOGUE

Alüminyum Kapı Pencere ve Giydirme Cephe Sistemleri
Aluminium Window Doors and Facade Systems

SKY65

AKSESUARLAR

ACCESSORIES

01



02

03

04

05

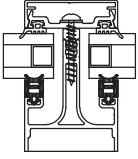
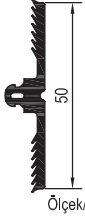
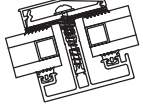
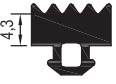
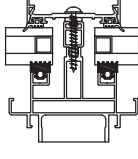
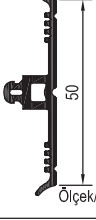
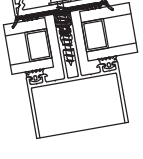
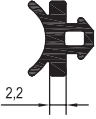
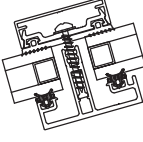
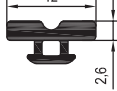
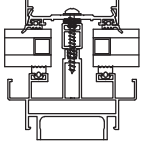
06

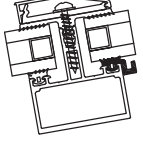
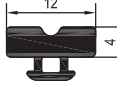
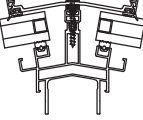
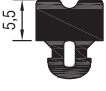
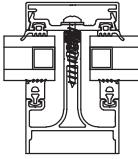
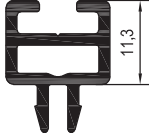
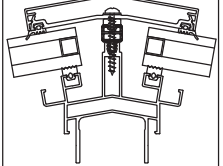
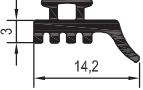
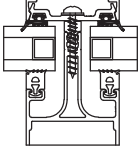
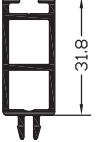
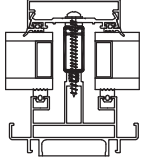
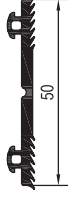
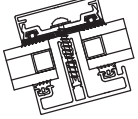
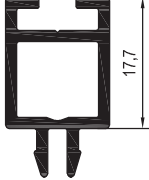
01	 <p>01.02.27 CAM FİTİLİ GLAZING GASKET Malzeme / Material : EPDM Ağırlık / Weight : 116 gr/m Paket / Package: 127 m / 15 kg</p>		 <p>01.11.06 KAPAK ALTI FİTİLİ GLAZING GASKET Malzeme / Material : EPDM Ağırlık / Weight : 228 gr/m Paket / Package: 65,8 m / 15 kg</p> <p>Ölçek/Scale: 1/2</p>	
02	 <p>01.02.11 CAM FİTİLİ GLAZING GASKET Malzeme / Material : EPDM Ağırlık / Weight : 87 gr/m Paket / Package: 172 m / 15 kg</p>		 <p>01.11.10 KAPAK ALTI FİTİLİ GLAZING GASKET Malzeme / Material : EPDM Ağırlık / Weight : 240 gr/m Paket / Package: 62,5 m / 15 kg</p> <p>Ölçek/Scale: 1/2</p>	
03	 <p>01.03.27 CAM FİTİLİ GLAZING GASKET Malzeme / Material : EPDM Ağırlık / Weight : 56 gr/m Paket / Package: 242 m / 15 kg</p>		 <p>01.15.01 ORTA FİTİLİ CENTRAL GASKET Malzeme / Material : EPDM Ağırlık / Weight : 52 gr/m Paket / Package: 288,46 m / 15 kg</p>	
04	 <p>01.03.08 CAM FİTİLİ GLAZING GASKET Malzeme / Material : EPDM Ağırlık / Weight : 100 gr/m Paket / Package: 150 m / 15 kg</p>		 <p>01.15.02 ORTA FİTİLİ CENTRAL GASKET Malzeme / Material : EPDM Ağırlık / Weight : 77 gr/m Paket / Package: 194,8 m / 15 kg</p>	
05	 <p>01.05.01 ORTA BASKI FİTİLİ CENTRAL GASKET Malzeme / Material : EPDM Ağırlık / Weight : 84 gr/m Paket / Package: 178 m / 15 kg</p>		 <p>02.01.11 PVC PROFİL PVC PROFILE Malzeme / Material : PVC</p>	
06	 <p>01.11.01 DIŞ CAM FİTİLİ GLAZING GASKET Malzeme / Material : EPDM Ağırlık / Weight : 65 gr/m Paket / Package: 230 m / 15 kg</p>		 <p>02.01.12 PVC PROFİL PVC PROFILE Malzeme / Material : PVC</p> <p>Ölçek/Scale: 1/2</p>	
	 <p>01.11.05 KAPAK ALTI FİTİLİ GLAZING GASKET Malzeme / Material : EPDM Ağırlık / Weight : 235 gr/m Paket / Package: 64 m / 15 kg</p> <p>Ölçek/Scale: 1/2</p>		 <p>04.08.03 PVC PROFİL PVC PROFILE Malzeme / Material : PVC</p>	