

# REWVG50

**RESCARA WINTER GARTEN  
SYSTEM**



# REWVG50

YALITIMLI KIS BAHCESI SISTEMI  
THERMO WINTERGARTEN SYSTEM

**PROFILLER**

**PROFILES**

# PROFİLLER PROFILES

# REWG50

ÇATI KRİŞ PROFİLİ  
RAFTER PROFILES

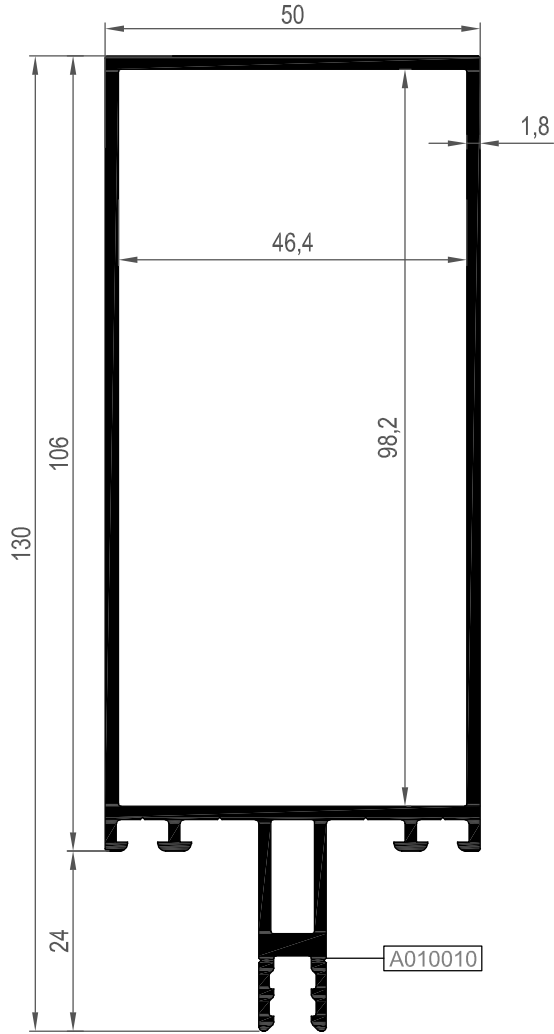
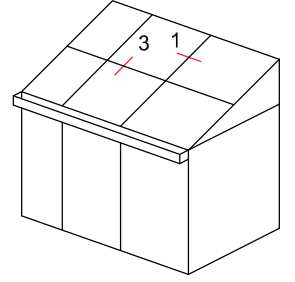

R50 T 05		
	<b>AĞIRLIK</b> WEIGHT (kg/m)	1,835
	<b>MALZEME</b> MATERIAL	Alüminyum
	<b>UZUNLUK</b> LENGTH (m)	6
	<b>Jx</b> (cm <sup>4</sup> )	118,752
	<b>Jy</b> (cm <sup>4</sup> )	25,792
	<b>KESİT No</b> SECTION No.	1-3

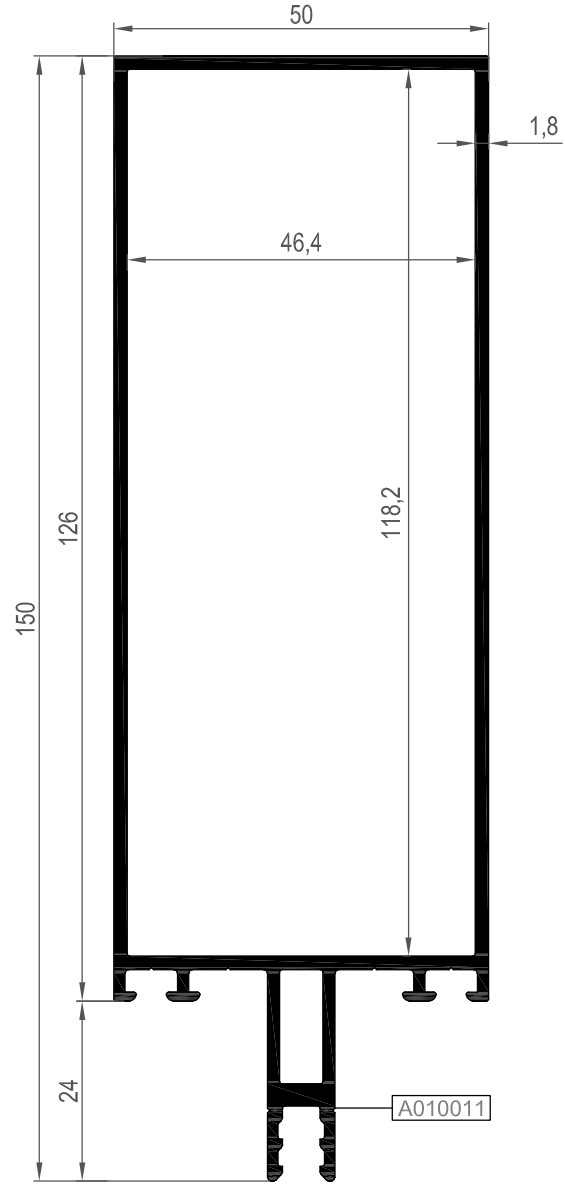

R50 T 06		
	<b>AĞIRLIK</b> WEIGHT (kg/m)	2,267
	<b>MALZEME</b> MATERIAL	Alüminyum
	<b>UZUNLUK</b> LENGTH (m)	6
	<b>Jx</b> (cm <sup>4</sup> )	217,04
	<b>Jy</b> (cm <sup>4</sup> )	31,376
	<b>KESİT No</b> SECTION No.	1-3

# PROFİLLER PROFILES

# REWG50

ÇATI YAN BİTİŞ PROFİLİ  
RAFTER PROFILES

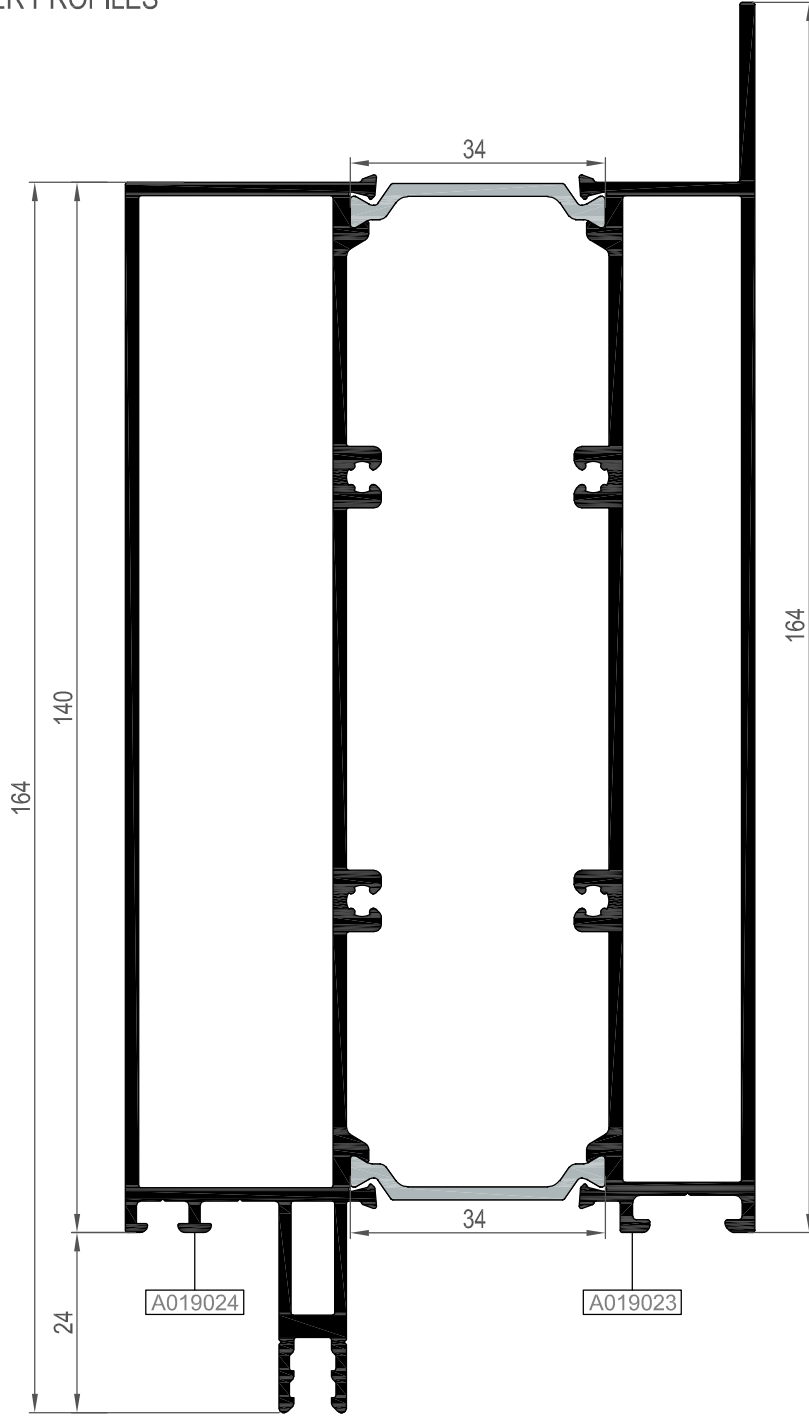
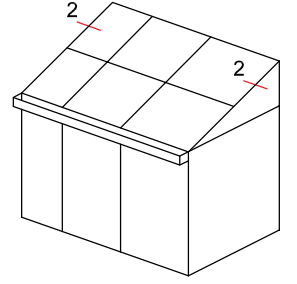

AREWG8201		
	<b>AĞIRLIK</b> WEIGHT (kg/m)	4,260
	<b>MALZEME</b> MATERIAL	Alüminyum
	<b>UZUNLUK</b> LENGTH (m)	6
	<b>Jx</b> (cm <sup>4</sup> )	
	<b>Jy</b> (cm <sup>4</sup> )	
	<b>KESİT No</b> SECTION No.	2



# PROFİLLER PROFILES

# REWG50

AÇILI ÇATI KRİŞİ PROFİLİ  
RAFTER PROFILES

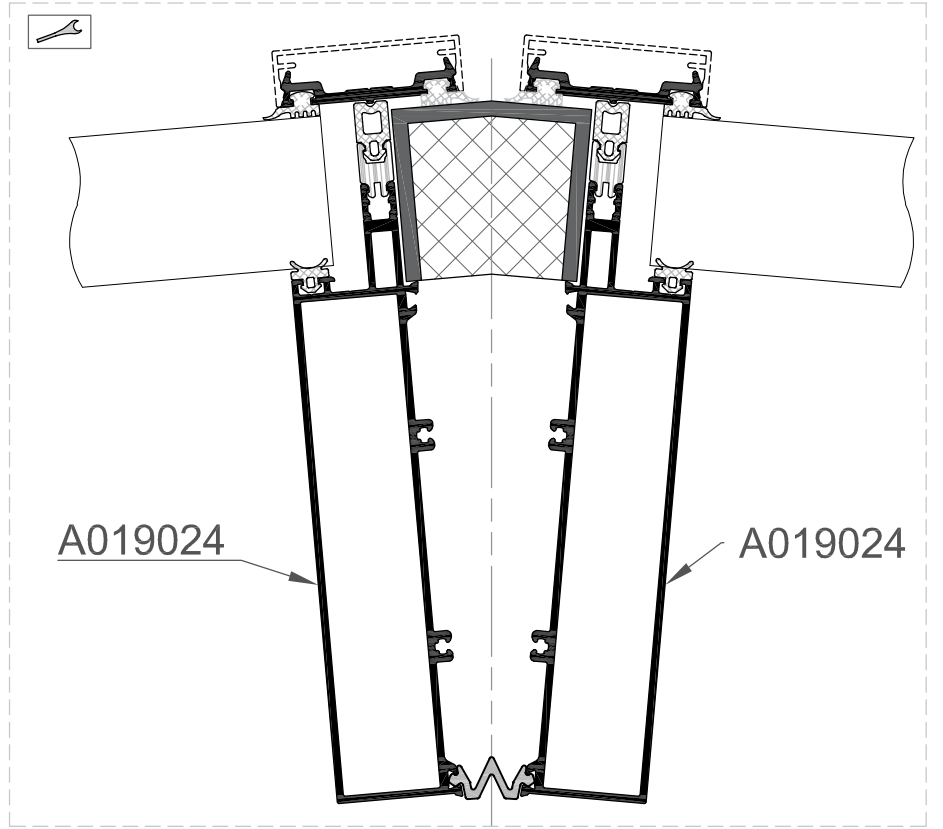
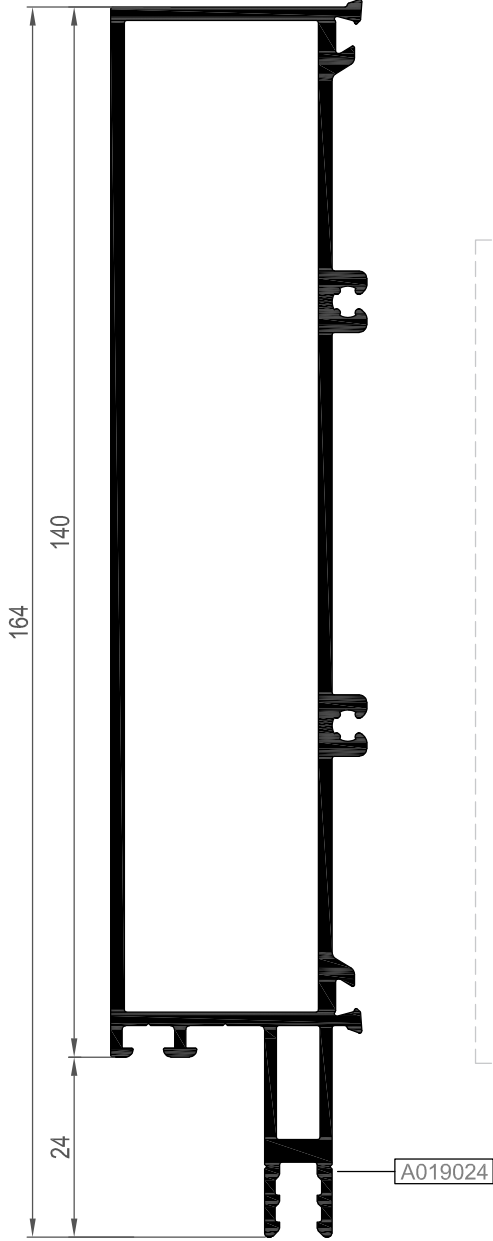
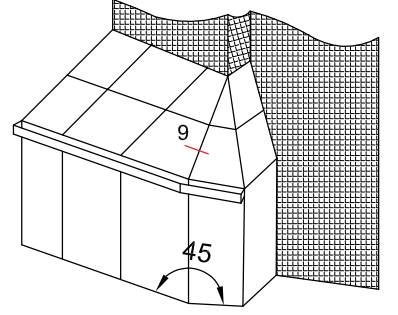

A019024		
	<b>AĞIRLIK</b> WEIGHT (kg/m)	2,146
	<b>MALZEME</b> MATERIAL	Alüminyum
	<b>UZUNLUK</b> LENGTH (m)	6
	<b>Jx</b> (cm <sup>4</sup> )	
	<b>Jy</b> (cm <sup>4</sup> )	
	<b>KESİT No</b> SECTION No.	9

# PROFİLLER PROFILES

# REWG50

ÇATI YATAY KRİŞ PROFİLLERİ  
TRANSOM PROFILES

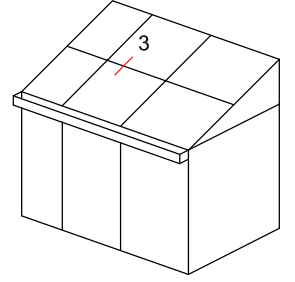

R50 T 04		
	<b>AĞIRLIK</b> WEIGHT (kg/m)	1,641
	<b>MALZEME</b> MATERIAL	Alüminyum
	<b>UZUNLUK</b> LENGTH (m)	6
	<b>Jx</b> (cm <sup>4</sup> )	74,492
	<b>Jy</b> (cm <sup>4</sup> )	21,619
	<b>KESİT No</b> SECTION No.	3

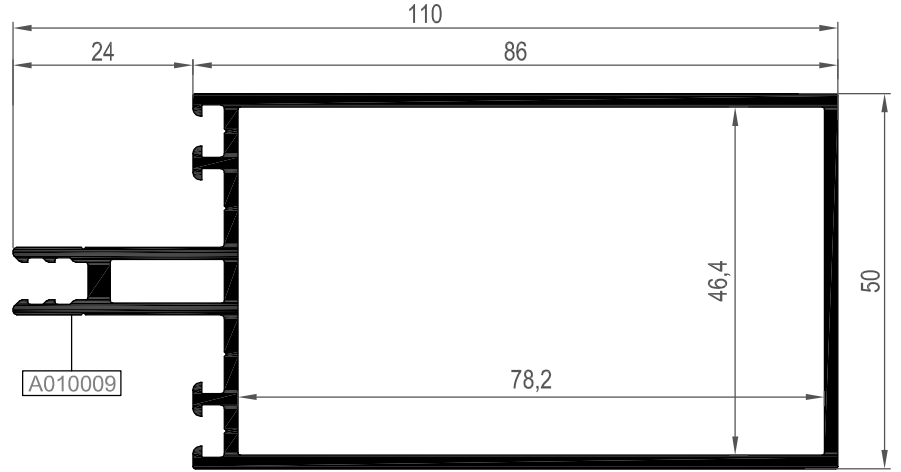

R50 T 03		
	<b>AĞIRLIK</b> WEIGHT (kg/m)	1,385
	<b>MALZEME</b> MATERIAL	Alüminyum
	<b>UZUNLUK</b> LENGTH (m)	6
	<b>Jx</b> (cm <sup>4</sup> )	34,528
	<b>Jy</b> (cm <sup>4</sup> )	16,162
	<b>KESİT No</b> SECTION No.	3

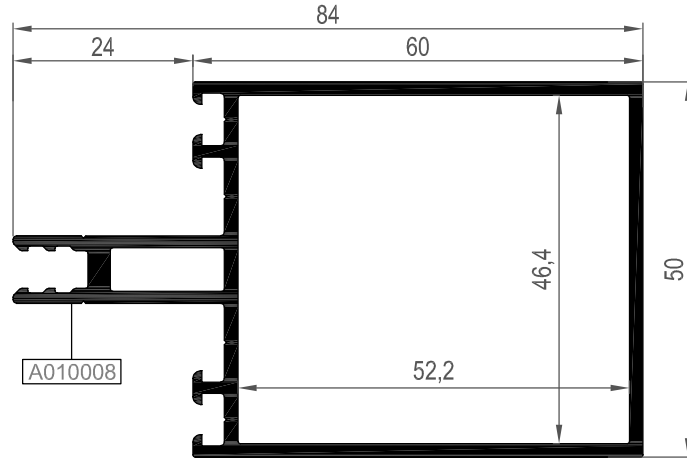

Nr	YATAY BAĞLANTI PROFİLİ		TRANSOM CONNECTION PROFILE		KESİM ÖLÇÜSÜ CUTTING SIZE	
	PROFİL KODU / PROFILE CODE	AKSESUAR KODU / ACCESSORY CODE	PROFİL KODU / PROFILE CODE	AKSESUAR KODU / ACCESSORY CODE		
R50 T 03	A010008	(A010026)		05.02.03		51,9 mm
R50 T 04	A010009	(A010026)		05.02.04		77,8 mm

# PROFİLLER PROFILES

# REWG50

ÇATI YATAY KRİŞ PROFİLLERİ  
TRANSOM PROFILES

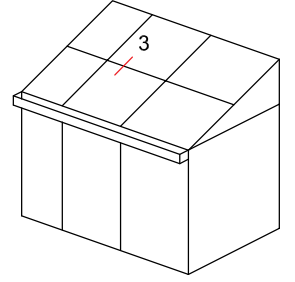

R50 T 02		
	<b>AĞIRLIK</b> WEIGHT (kg/m)	1,288
	<b>MALZEME</b> MATERIAL	Alüminyum
	<b>UZUNLUK</b> LENGTH (m)	6
	<b>Jx</b> (cm <sup>4</sup> )	23,932
	<b>Jy</b> (cm <sup>4</sup> )	14,077
	<b>KESİT No</b> SECTION No.	3

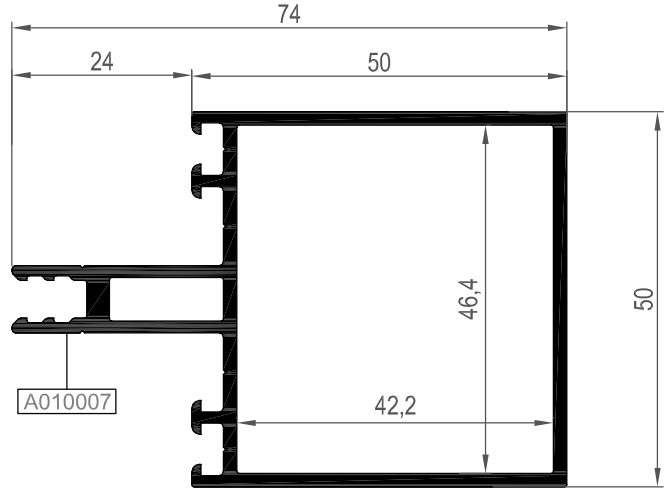

R50 T 01		
	<b>AĞIRLIK</b> WEIGHT (kg/m)	1,218
	<b>MALZEME</b> MATERIAL	Alüminyum
	<b>UZUNLUK</b> LENGTH (m)	6
	<b>Jx</b> (cm <sup>4</sup> )	11,053
	<b>Jy</b> (cm <sup>4</sup> )	10,72
	<b>KESİT No</b> SECTION No.	3

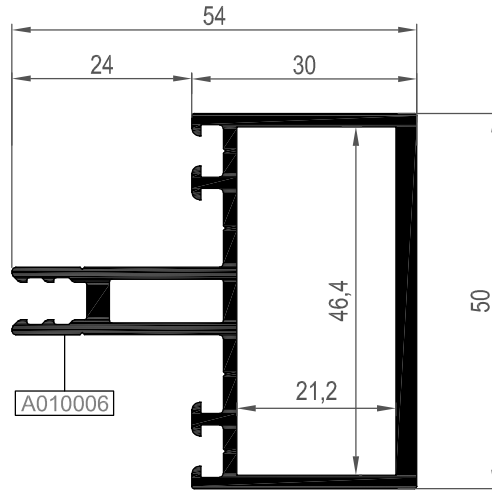

Nr	YATAY BAĞLANTI PROFİLİ		TRANSOM CONNECTION PROFILE		KESİM ÖLÇÜSÜ CUTTING SIZE	
	PROFİL KODU / PROFILE CODE	AKSESUAR KODU / ACCESSORY CODE	AKSESUAR KODU / ACCESSORY CODE	AKSESUAR KODU / ACCESSORY CODE		
R50 T 01	A010006	(A010026)		05.02.01		20,7 mm
R50 T 02	A010007	(A010026)		05.02.02		41,9 mm

# PROFİLLER PROFILES

# REWG50

DÜŞEY PROFİLLER  
MULLION PROFILES

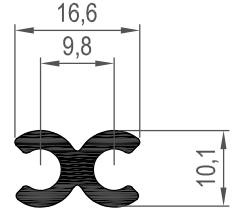
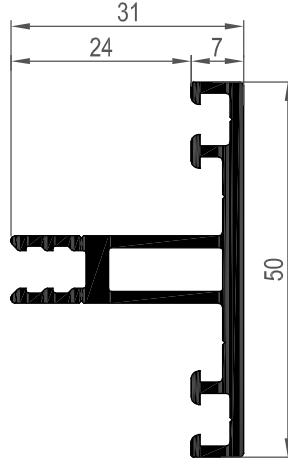
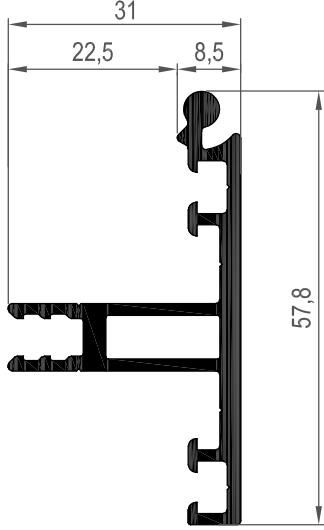
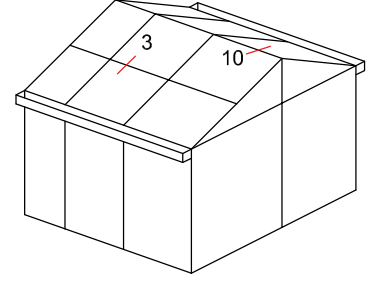

**REWG 5302		
<b>AĞIRLIK</b> WEIGHT (kg/m)		0,816
<b>MALZEME</b> MATERIAL		Alüminyum
<b>UZUNLUK</b> LENGTH (m)		6
<b>Jx</b> (cm <sup>4</sup> )		
<b>Jy</b> (cm <sup>4</sup> )		
<b>KESİT No</b> SECTION No.		10

**REWG 5301		
<b>AĞIRLIK</b> WEIGHT (kg/m)		0,731
<b>MALZEME</b> MATERIAL		Alüminyum
<b>UZUNLUK</b> LENGTH (m)		6
<b>Jx</b> (cm <sup>4</sup> )		
<b>Jy</b> (cm <sup>4</sup> )		
<b>KESİT No</b> SECTION No.		3

**REWG 1008		
<b>AĞIRLIK</b> WEIGHT (kg/m)		0,230
<b>MALZEME</b> MATERIAL		Alüminyum
<b>UZUNLUK</b> LENGTH (m)		6
<b>Jx</b> (cm <sup>4</sup> )		
<b>Jy</b> (cm <sup>4</sup> )		
<b>KESİT No</b> SECTION No.		10

\*\*Kalıp aktif değildir. Sipariş üzerine yapılacaktır.  
The die is not active. It will be produced by order.

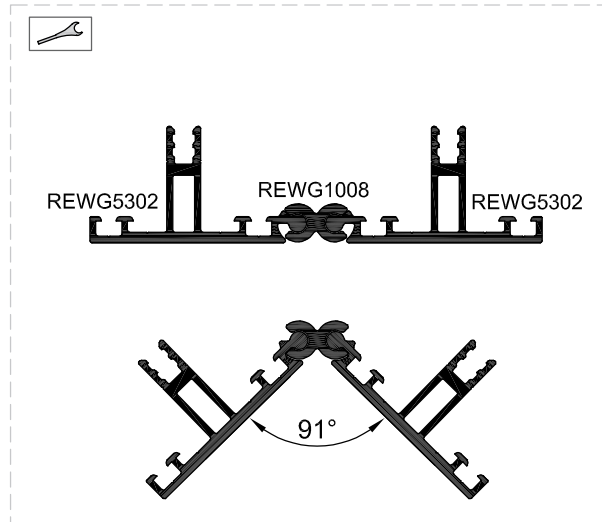

## ADAPTÖR PROFİLLERİ ADAPTER PROFILES

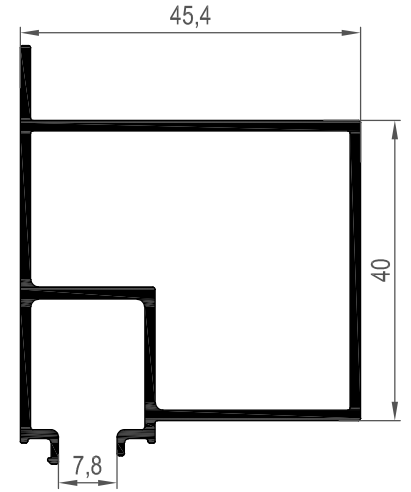
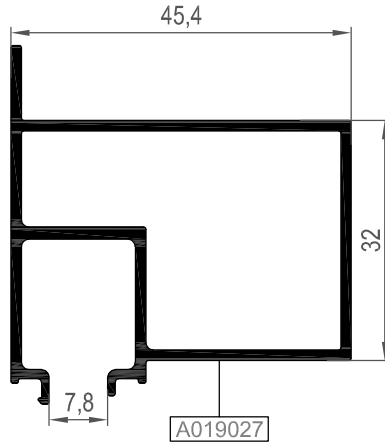
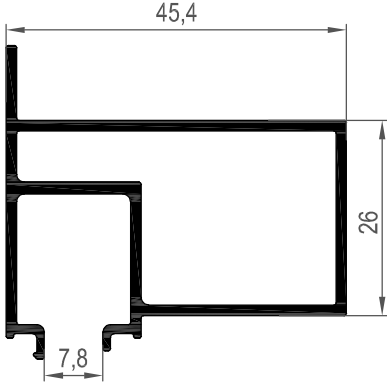

**REWG 1007	
	<b>AĞIRLIK</b> WEIGHT (kg/m) 0,692
	<b>MALZEME</b> MATERIAL Alüminyum
	<b>UZUNLUK</b> LENGTH (m) 6
	<b>Jx</b> (cm <sup>4</sup> )
	<b>Jy</b> (cm <sup>4</sup> )
	<b>KESİT No</b> SECTION No. 2

REWG 1001	
	<b>AĞIRLIK</b> WEIGHT (kg/m) 0,739
	<b>MALZEME</b> MATERIAL Alüminyum
	<b>UZUNLUK</b> LENGTH (m) 6
	<b>Jx</b> (cm <sup>4</sup> )
	<b>Jy</b> (cm <sup>4</sup> )
	<b>KESİT No</b> SECTION No. 2

**REWG 1006	
	<b>AĞIRLIK</b> WEIGHT (kg/m) 0,798
	<b>MALZEME</b> MATERIAL Alüminyum
	<b>UZUNLUK</b> LENGTH (m) 6
	<b>Jx</b> (cm <sup>4</sup> )
	<b>Jy</b> (cm <sup>4</sup> )
	<b>KESİT No</b> SECTION No. 2

\*\*Kalıp aktif değildir. Sipariş üzerine yapılacaktır.  
The die is not active. It will be produced by order.

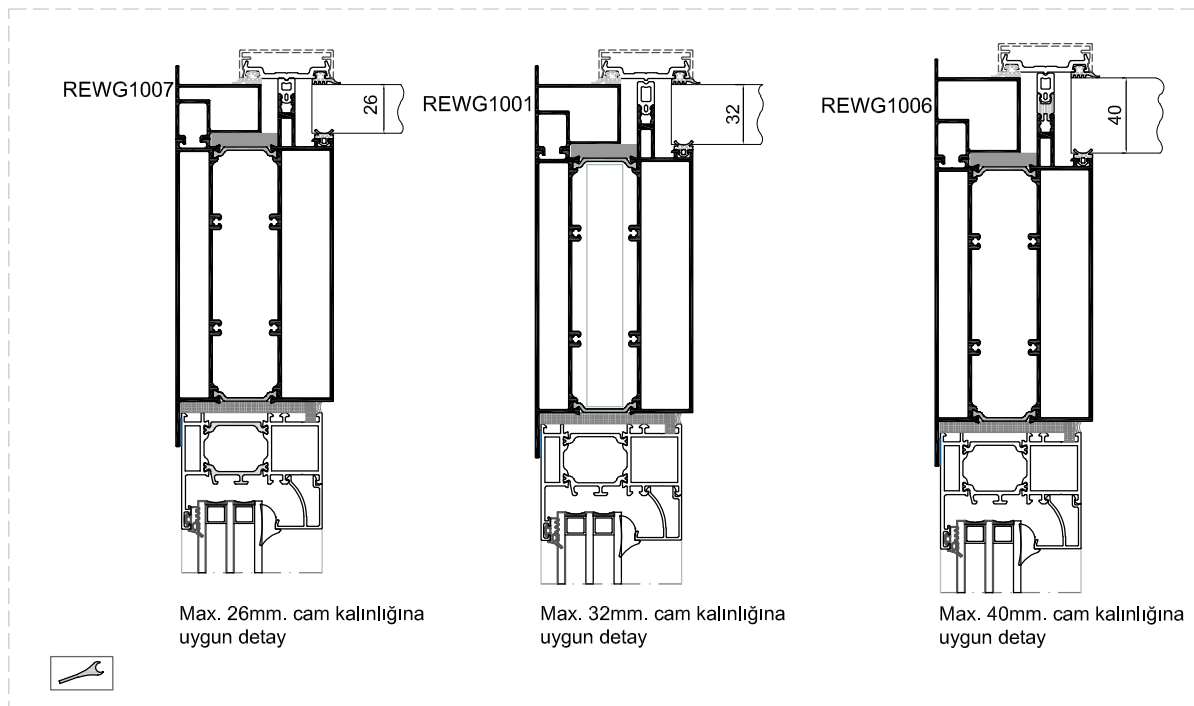





Max. 26mm. cam kalınlığına uygun detay





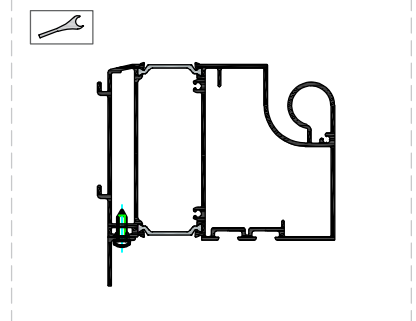
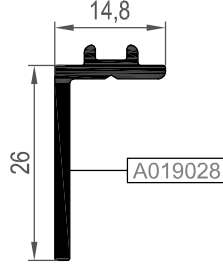

Max. 32mm. cam kalınlığına uygun detay

Max. 40mm. cam kalınlığına uygun detay



## ADAPTÖR PROFİLLERİ ADAPTER PROFILES

REWG 1002		
	<b>AĞIRLIK</b> WEIGHT (kg/m)	0,230
	<b>MALZEME</b> MATERIAL	Alüminyum
	<b>UZUNLUK</b> LENGTH (m)	6
	<b>Jx</b> (cm <sup>4</sup> )	
	<b>Jy</b> (cm <sup>4</sup> )	
	<b>KESİT No</b> SECTION No.	5



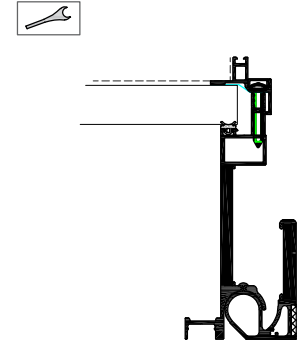
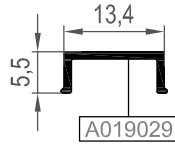



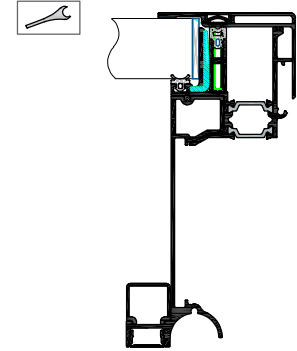
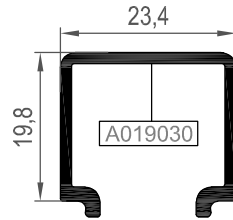

REWG 1003		
	<b>AĞIRLIK</b> WEIGHT (kg/m)	0,062
	<b>MALZEME</b> MATERIAL	Alüminyum
	<b>UZUNLUK</b> LENGTH (m)	6
	<b>Jx</b> (cm <sup>4</sup> )	
	<b>Jy</b> (cm <sup>4</sup> )	
	<b>KESİT No</b> SECTION No.	4



REWG 1004		
	<b>AĞIRLIK</b> WEIGHT (kg/m)	0,297
	<b>MALZEME</b> MATERIAL	Alüminyum
	<b>UZUNLUK</b> LENGTH (m)	6
	<b>Jx</b> (cm <sup>4</sup> )	
	<b>Jy</b> (cm <sup>4</sup> )	
	<b>KESİT No</b> SECTION No.	4-5



REWG 1005		
	<b>AĞIRLIK</b> WEIGHT (kg/m)	0,117
	<b>MALZEME</b> MATERIAL	Alüminyum
	<b>UZUNLUK</b> LENGTH (m)	6
	<b>Jx</b> (cm <sup>4</sup> )	
	<b>Jy</b> (cm <sup>4</sup> )	
	<b>KESİT No</b> SECTION No.	4-5

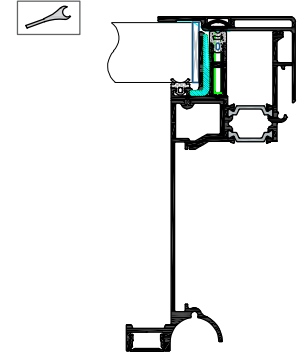
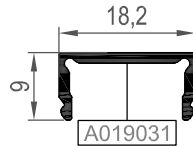





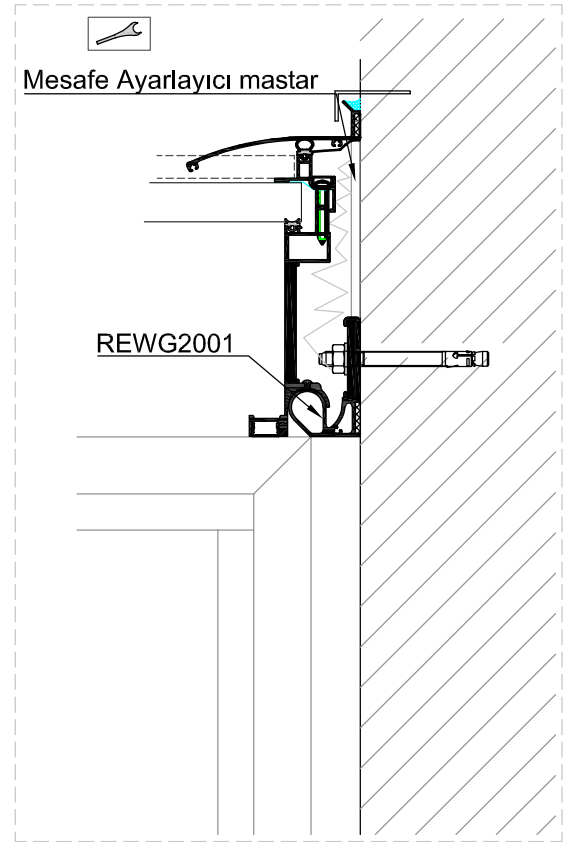
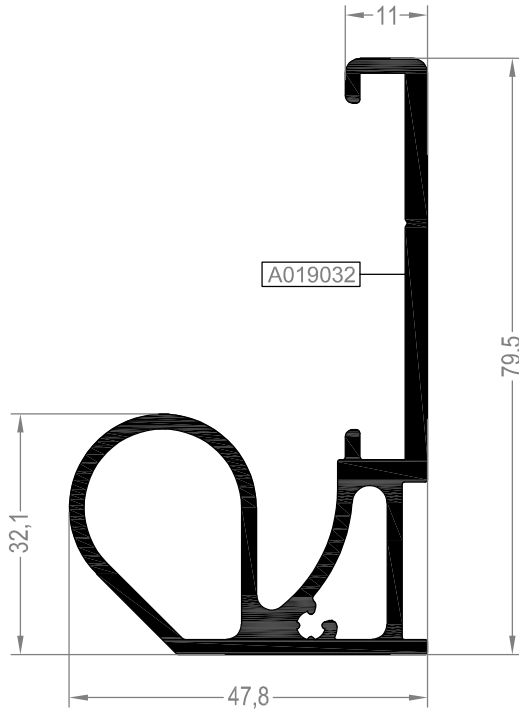
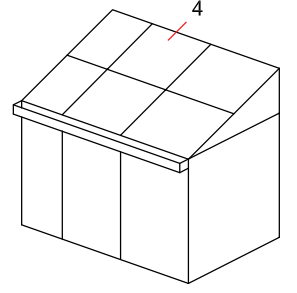

# PROFİLLER PROFILES

# REWG50





DUVAR BAĞLANTI PROFİLLERİ  
WALL ATTACHMENT



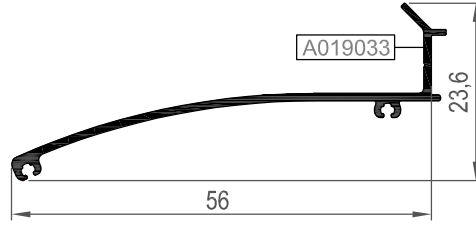
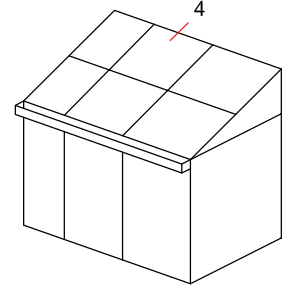



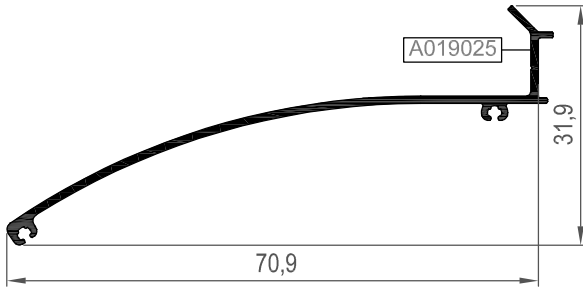

REWG 2001		
	<b>AĞIRLIK</b> WEIGHT (kg/m)	1,527
	<b>MALZEME</b> MATERIAL	Alüminyum
	<b>UZUNLUK</b> LENGTH (m)	6
	<b>Jx</b> (cm <sup>4</sup> )	
	<b>Jy</b> (cm <sup>4</sup> )	
	<b>KESİT No</b> SECTION No.	4

SAÇAK PROFİLLERİ  
FIRST RIDGE







REWG 3001		
	<b>AĞIRLIK</b> WEIGHT (kg/m)	0,882
	<b>MALZEME</b> MATERIAL	Alüminyum
	<b>UZUNLUK</b> LENGTH (m)	6
	<b>Jx</b> (cm <sup>4</sup> )	
	<b>Jy</b> (cm <sup>4</sup> )	
	<b>KESİT No</b> SECTION No.	4

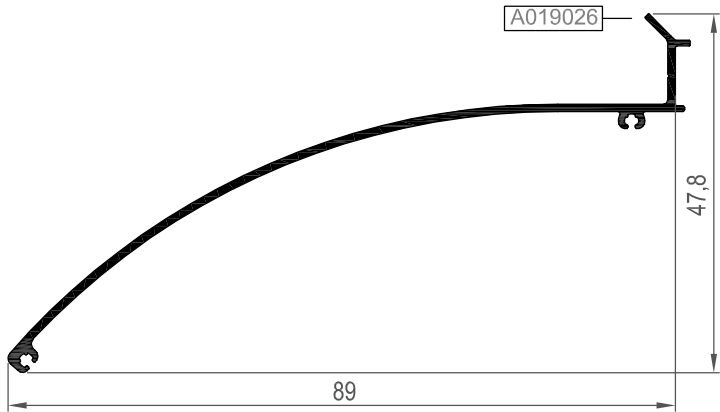

REWG 3002		
	<b>AĞIRLIK</b> WEIGHT (kg/m)	1,068
	<b>MALZEME</b> MATERIAL	Alüminyum
	<b>UZUNLUK</b> LENGTH (m)	6
	<b>Jx</b> (cm <sup>4</sup> )	
	<b>Jy</b> (cm <sup>4</sup> )	
	<b>KESİT No</b> SECTION No.	4



REWG 3003		
	<b>AĞIRLIK</b> WEIGHT (kg/m)	1,333
	<b>MALZEME</b> MATERIAL	Alüminyum
	<b>UZUNLUK</b> LENGTH (m)	6
	<b>Jx</b> (cm <sup>4</sup> )	
	<b>Jy</b> (cm <sup>4</sup> )	
	<b>KESİT No</b> SECTION No.	4



## SAÇAK PROFİLLERİ FIRST RIDGE

(0-20 DERECE)

(8-30 DERECE)

(22-45 DERECE)

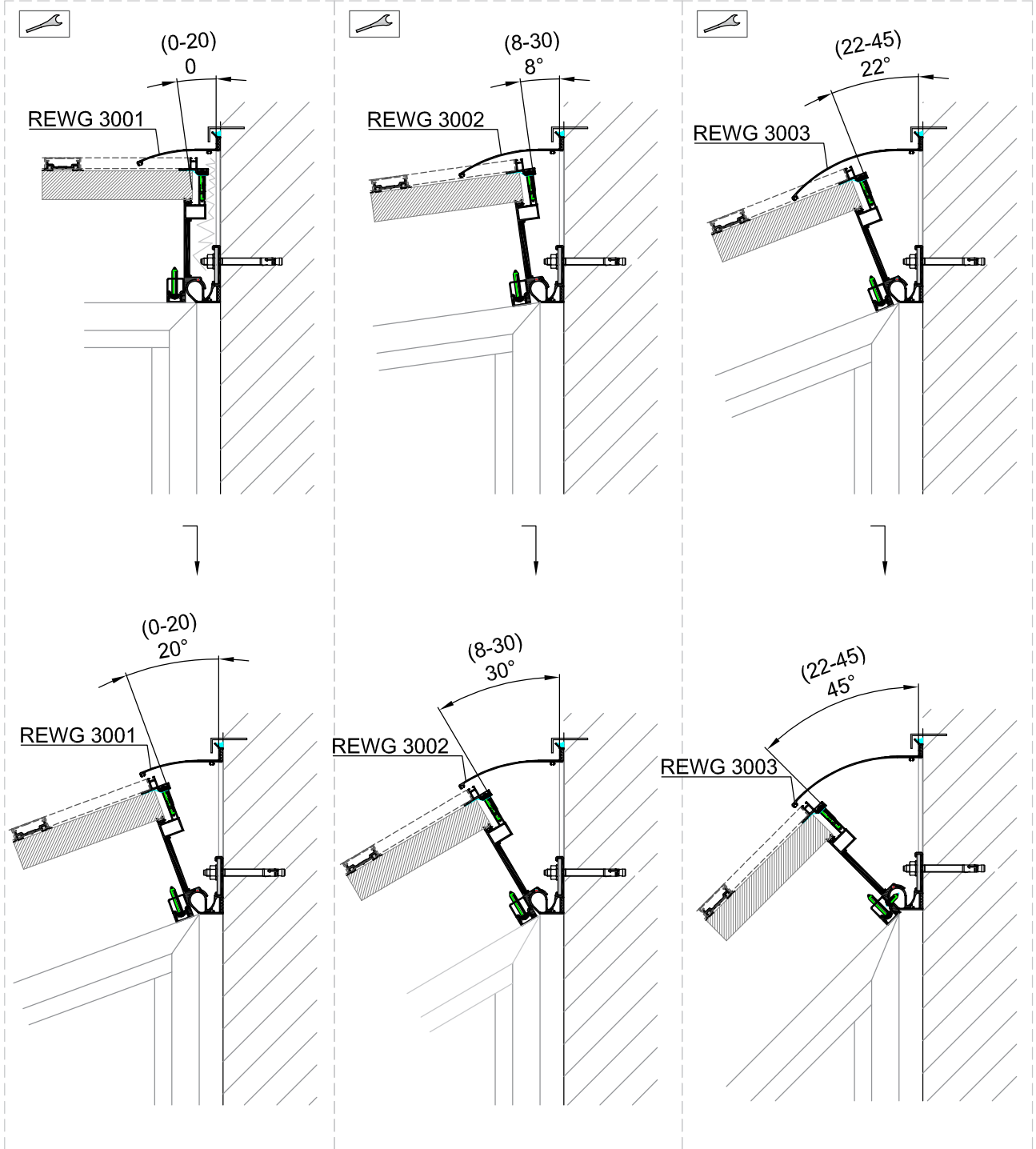

# PROFİLLER PROFILES

# REWG50

SAÇAK UÇ PLAKASI  
EAVES END PLATE

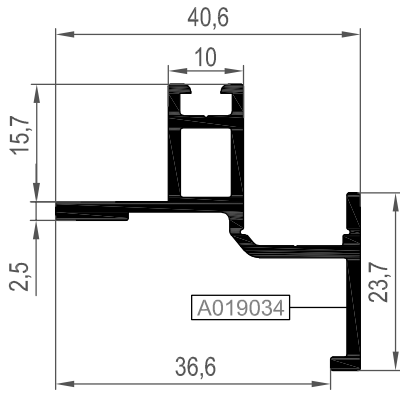
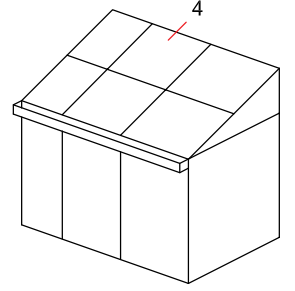

REWG 3101		
	<b>AĞIRLIK</b> WEIGHT (kg/m)	0,515
	<b>MALZEME</b> MATERIAL	Alüminyum
	<b>UZUNLUK</b> LENGTH (m)	6
	<b>Jx</b> (cm <sup>4</sup> )	
	<b>Jy</b> (cm <sup>4</sup> )	
	<b>KESİT No</b> SECTION No.	4

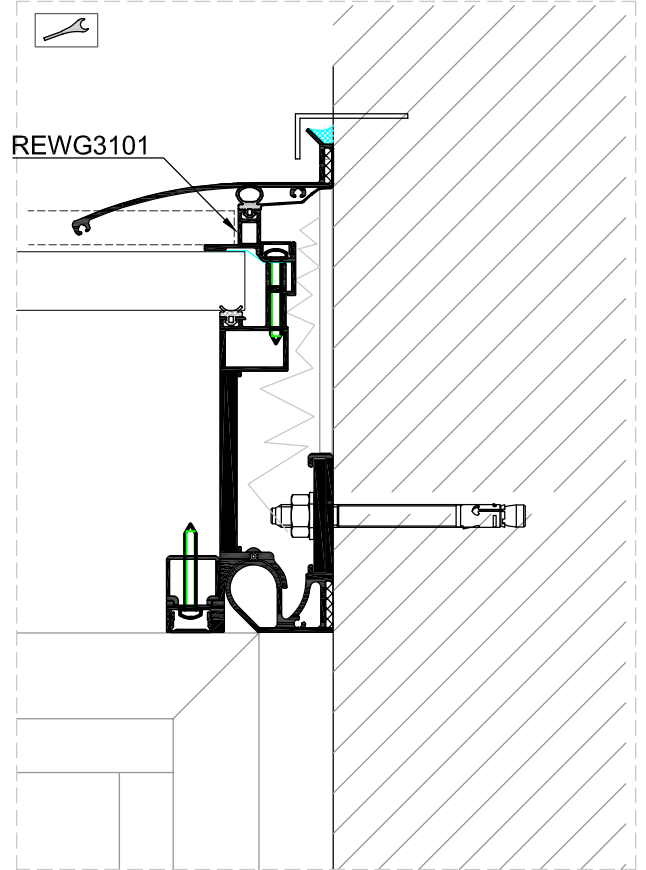



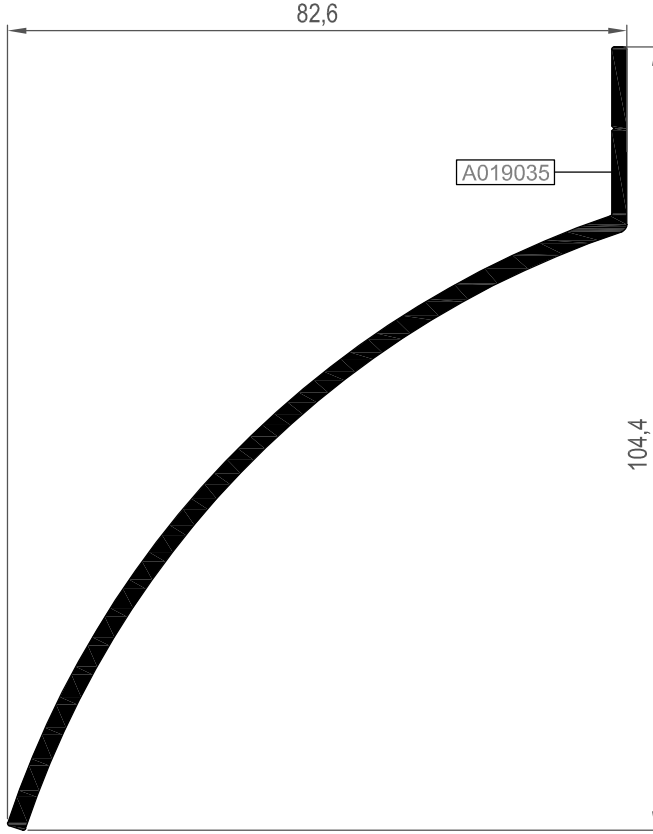
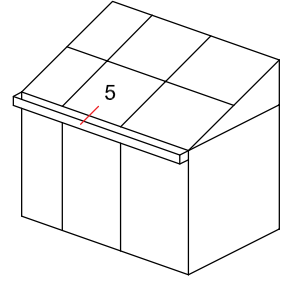

# PROFİLLER PROFILES

# REWG50

SAÇAK VE ÖN KRİŞ MAFSALLI PROFİLLERİ  
EAVES END EDGE JOINTS



REWG 3201		
 <b>AĞIRLIK</b> WEIGHT (kg/m)	0,927	
 <b>MALZEME</b> MATERIAL	Alüminyum	
 <b>UZUNLUK</b> LENGTH (m)	6	
 <b>Jx</b> (cm <sup>4</sup> )		
 <b>Jy</b> (cm <sup>4</sup> )		
 <b>KESİT No</b> SECTION No.	5	

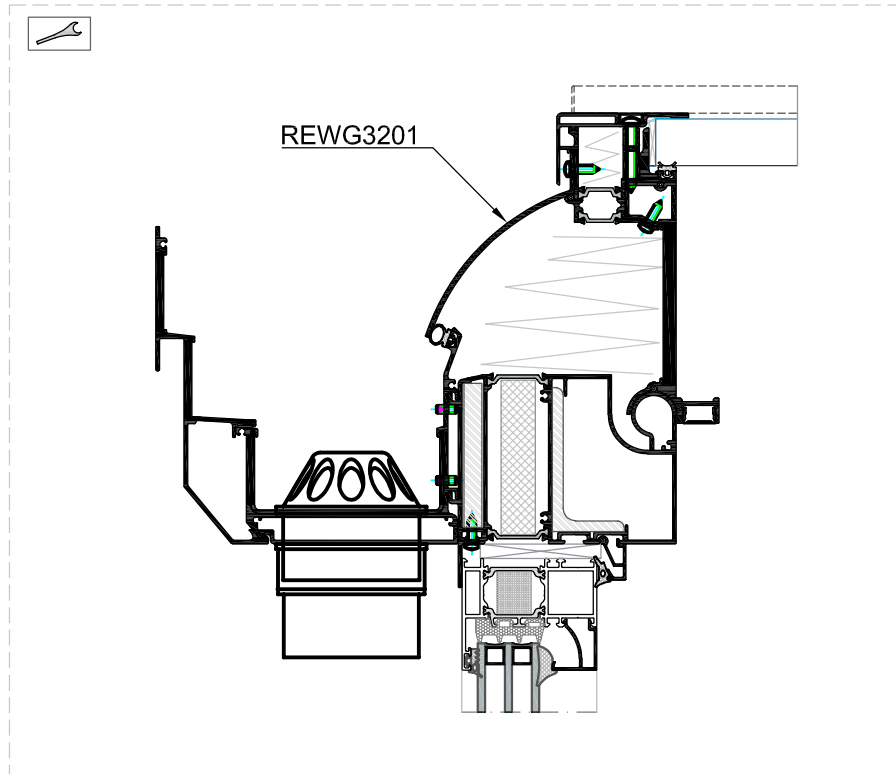

# PROFİLLER PROFILES

# REWG50

SAÇAK KAPAK PROFİLİ  
EAVES COVER PROFILE

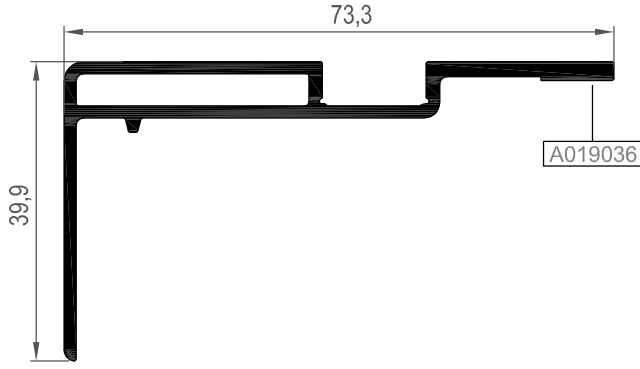
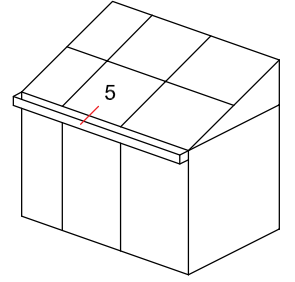

REWG 3301		
<b>AĞIRLIK</b> WEIGHT (kg/m)		0,718
<b>MALZEME</b> MATERIAL		Alüminyum
<b>UZUNLUK</b> LENGTH (m)		6
<b>Jx</b> (cm <sup>4</sup> )		
<b>Jy</b> (cm <sup>4</sup> )		
<b>KESİT No</b> SECTION No.		5

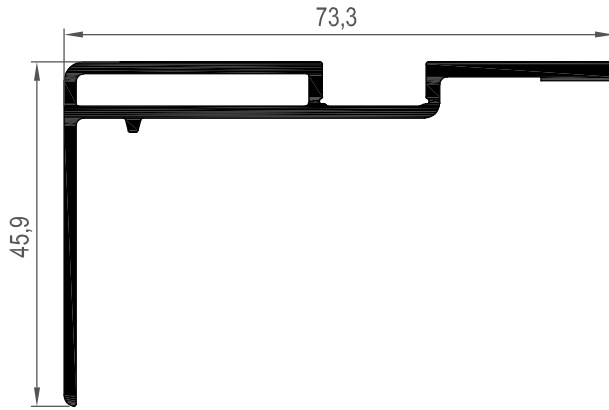

**REWG 3305		
<b>AĞIRLIK</b> WEIGHT (kg/m)		0,744
<b>MALZEME</b> MATERIAL		Alüminyum
<b>UZUNLUK</b> LENGTH (m)		6
<b>Jx</b> (cm <sup>4</sup> )		
<b>Jy</b> (cm <sup>4</sup> )		
<b>KESİT No</b> SECTION No.		5

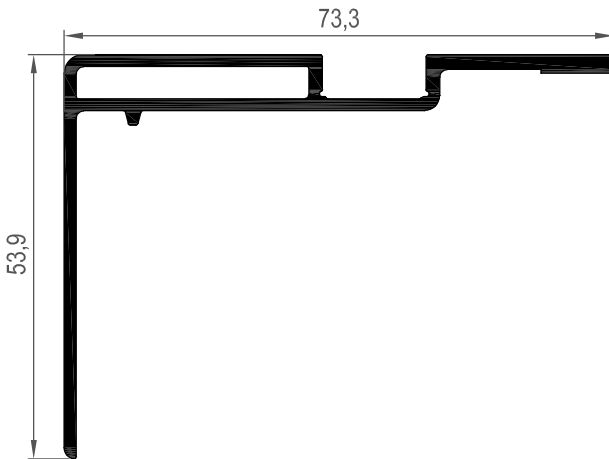

**REWG 3306		
<b>AĞIRLIK</b> WEIGHT (kg/m)		0,778
<b>MALZEME</b> MATERIAL		Alüminyum
<b>UZUNLUK</b> LENGTH (m)		6
<b>Jx</b> (cm <sup>4</sup> )		
<b>Jy</b> (cm <sup>4</sup> )		
<b>KESİT No</b> SECTION No.		5

\*\*Kalıp aktif değildir. Sipariş üzerine yapılacaktır.  
The die is not active. It will be produced by order.

## SAÇAK KAPAK PROFİLİ EAVES COVER PROFILE

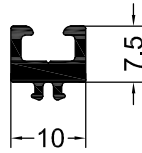
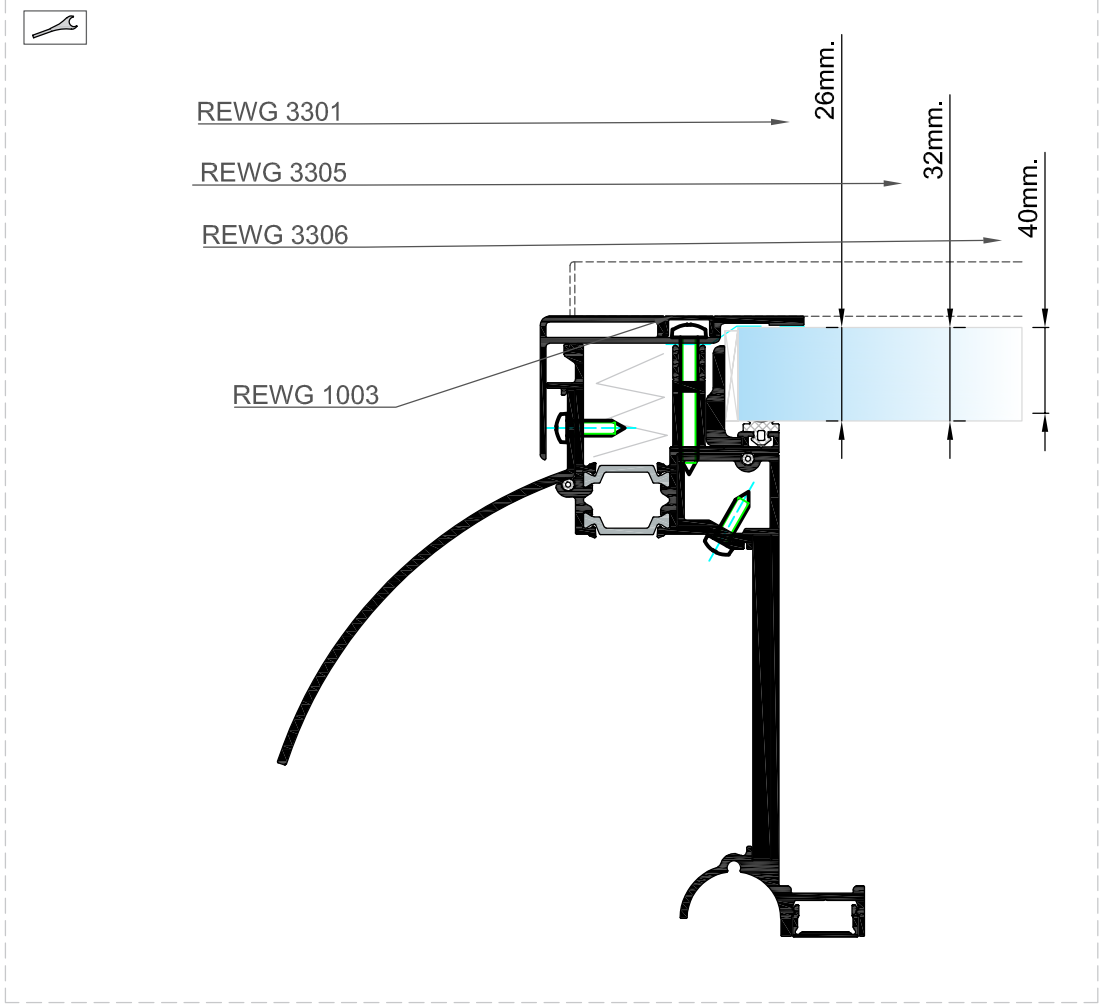

R50 G 06		
 <b>AĞIRLIK</b> WEIGHT (kg/m)		0,136
 <b>MALZEME</b> MATERIAL		Alüminyum
 <b>UZUNLUK</b> LENGTH (m)		6
 <b>Jx</b> (cm <sup>4</sup> )		
 <b>Jy</b> (cm <sup>4</sup> )		
 <b>KESİT No</b> SECTION No.		

# PROFİLLER PROFILES

# REWG50

SAÇAK KAPAK PROFİLİ  
EAVES COVER PROFILE

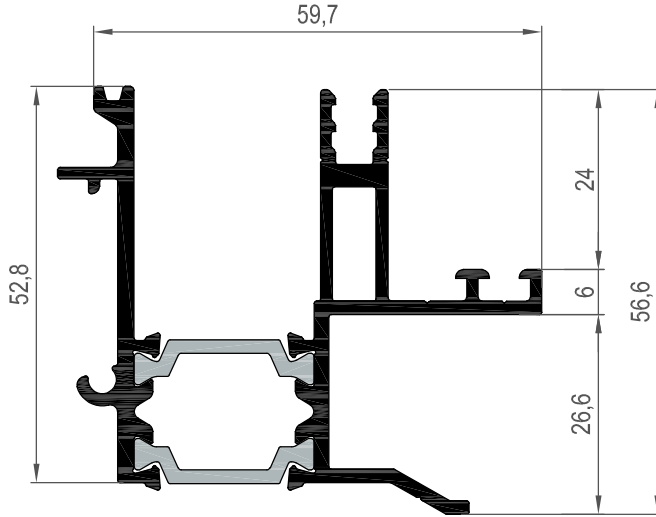
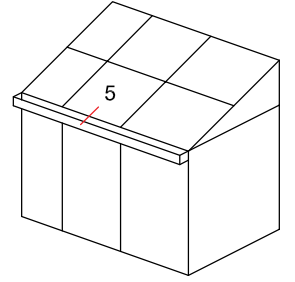

**AREWG3303		
	<b>AĞIRLIK</b> WEIGHT (kg/m)	1,415
	<b>MALZEME</b> MATERIAL	Alüminyum
	<b>UZUNLUK</b> LENGTH (m)	6
	<b>Jx</b> (cm <sup>4</sup> )	
	<b>Jy</b> (cm <sup>4</sup> )	
	<b>KESİT No</b> SECTION No.	5

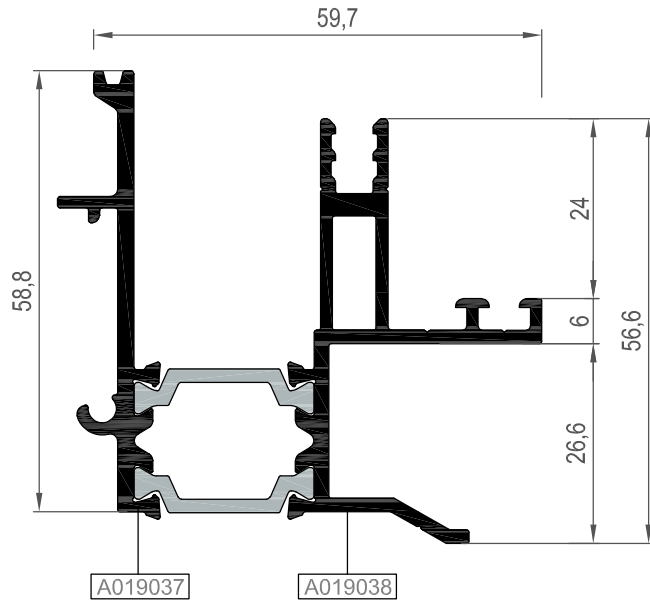

AREWG3302		
	<b>AĞIRLIK</b> WEIGHT (kg/m)	1,452
	<b>MALZEME</b> MATERIAL	Alüminyum
	<b>UZUNLUK</b> LENGTH (m)	6
	<b>Jx</b> (cm <sup>4</sup> )	
	<b>Jy</b> (cm <sup>4</sup> )	
	<b>KESİT No</b> SECTION No.	5

\*\*Kalıp aktif değildir. Sipariş üzerine yapılacaktır.  
The die is not active. It will be produced by order.

# PROFİLLER PROFILES

# REWG50

SAÇAK KAPAK PROFİLİ  
EAVES COVER PROFILE

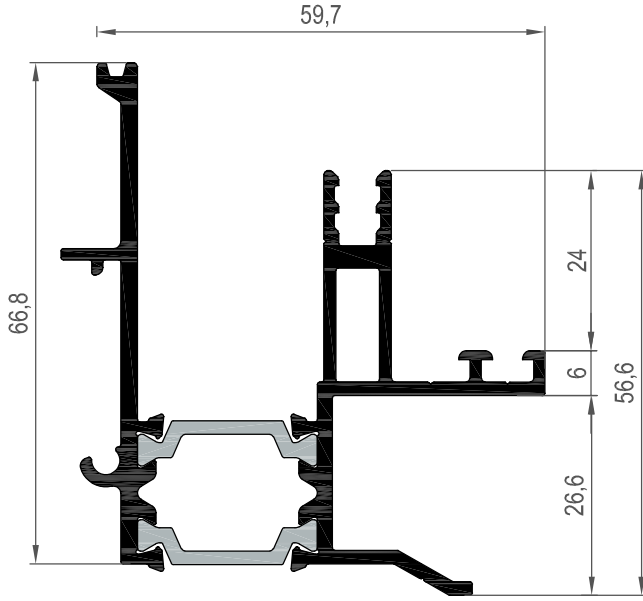
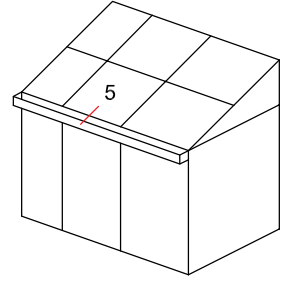

**AREWG3304		
	<b>AĞIRLIK</b> WEIGHT (kg/m)	1,499
	<b>MALZEME</b> MATERIAL	Alüminyum
	<b>UZUNLUK</b> LENGTH (m)	6
	<b>Jx</b> (cm <sup>4</sup> )	
	<b>Jy</b> (cm <sup>4</sup> )	
	<b>KESİT No</b> SECTION No.	5

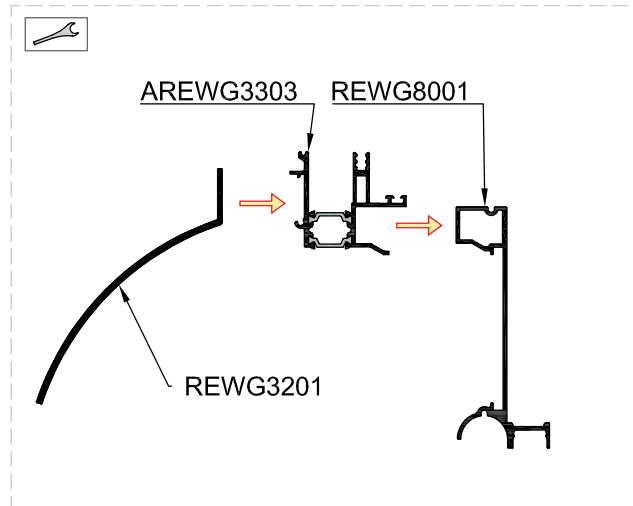

\*\*Kalıp aktif değildir. Sipariş üzerine yapılacaktır.  
The die is not active. It will be produced by order.

## SAÇAK KAPAK PROFİLİ EAVES COVER PROFILE

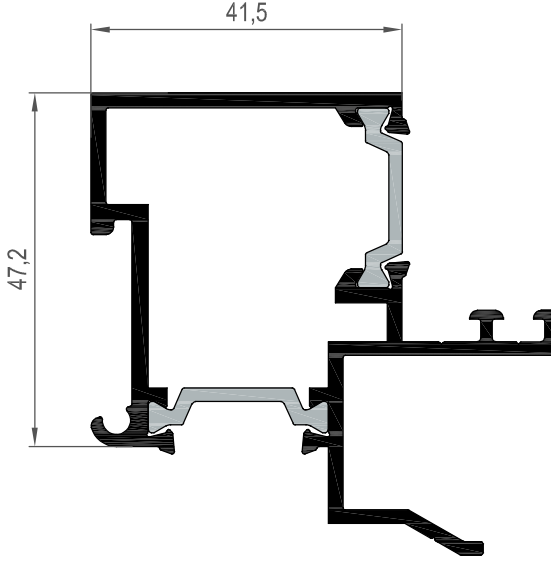
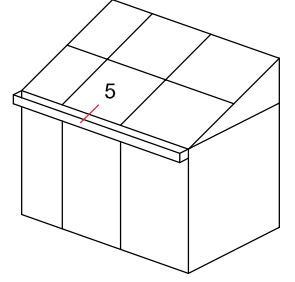

**AREWG3307		
	<b>AĞIRLIK</b> WEIGHT (kg/m)	1,344
	<b>MALZEME</b> MATERIAL	Alüminyum
	<b>UZUNLUK</b> LENGTH (m)	6
	<b>Jx</b> (cm <sup>4</sup> )	
	<b>Jy</b> (cm <sup>4</sup> )	
	<b>KESİT No</b> SECTION No.	5

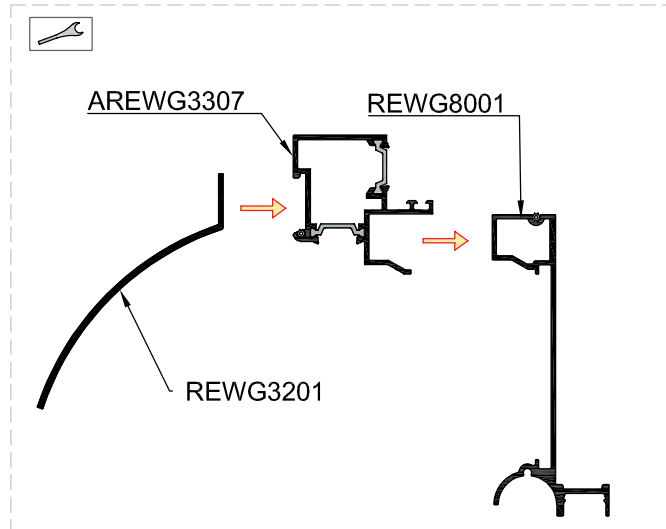

\*\*Kalıp aktif değildir. Sipariş üzerine yapılacaktır.  
The die is not active. It will be produced by order.



## DESTEK PROFİLLERİ SUPPORT PROFILES

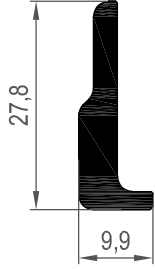

**REWG4009		
	<b>AĞIRLIK</b> WEIGHT (kg/m)	0,347
	<b>MALZEME</b> MATERIAL	Alüminyum
	<b>UZUNLUK</b> LENGTH (m)	6
	<b>Jx</b> (cm <sup>4</sup> )	
	<b>Jy</b> (cm <sup>4</sup> )	
	<b>KESİT No</b> SECTION No.	5

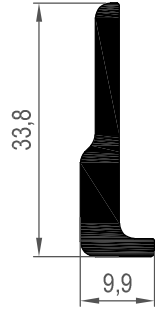
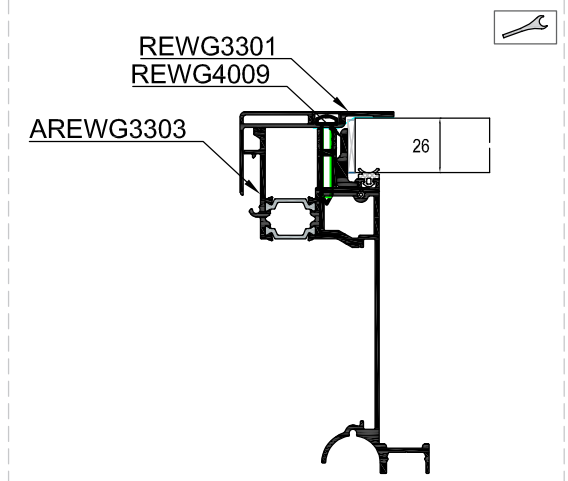

**REWG4010		
	<b>AĞIRLIK</b> WEIGHT (kg/m)	0,399
	<b>MALZEME</b> MATERIAL	Alüminyum
	<b>UZUNLUK</b> LENGTH (m)	6
	<b>Jx</b> (cm <sup>4</sup> )	
	<b>Jy</b> (cm <sup>4</sup> )	
	<b>KESİT No</b> SECTION No.	5

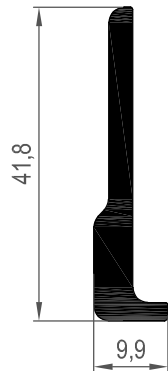
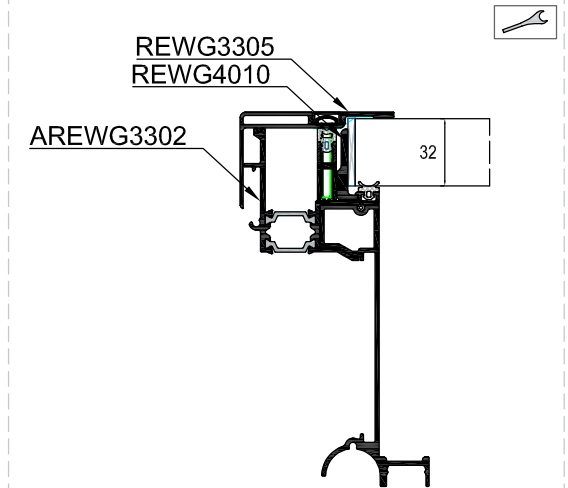



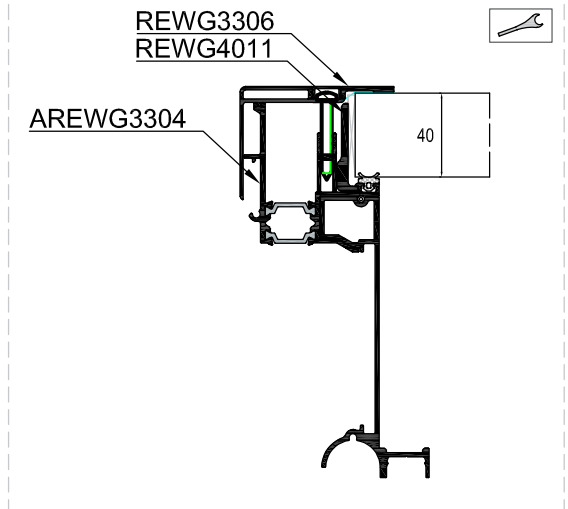



**REWG4011		
	<b>AĞIRLIK</b> WEIGHT (kg/m)	0,468
	<b>MALZEME</b> MATERIAL	Alüminyum
	<b>UZUNLUK</b> LENGTH (m)	6
	<b>Jx</b> (cm <sup>4</sup> )	
	<b>Jy</b> (cm <sup>4</sup> )	
	<b>KESİT No</b> SECTION No.	5



\*\*Kalıp aktif değildir. Sipariş üzerine yapılacaktır.  
The die is not active. It will be produced by order.

## DESTEK PROFİLLERİ SUPPORT PROFILES

**AREWG4007		
	<b>AĞIRLIK</b> WEIGHT (kg/m)	2,175
	<b>MALZEME</b> MATERIAL	Alüminyum
	<b>UZUNLUK</b> LENGTH (m)	6
	<b>Jx</b> (cm <sup>2</sup> )	
	<b>Jy</b> (cm <sup>2</sup> )	
	<b>KESİT No</b> SECTION No.	6

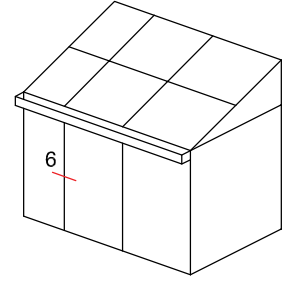
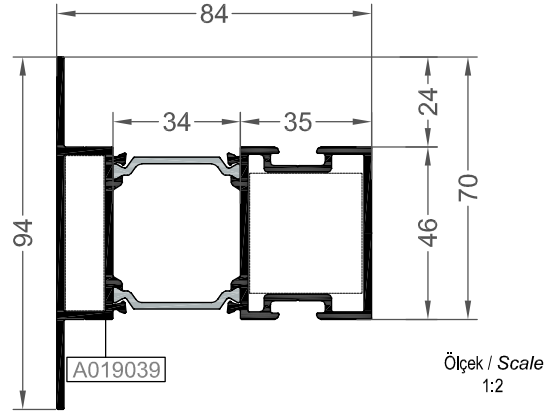

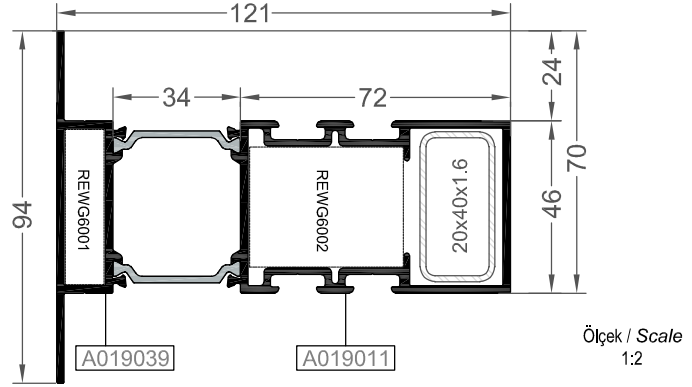

AREWG4001		
	<b>AĞIRLIK</b> WEIGHT (kg/m)	2,739
	<b>MALZEME</b> MATERIAL	Alüminyum
	<b>UZUNLUK</b> LENGTH (m)	6
	<b>Jx</b> (cm <sup>2</sup> )	
	<b>Jy</b> (cm <sup>2</sup> )	
	<b>KESİT No</b> SECTION No.	6

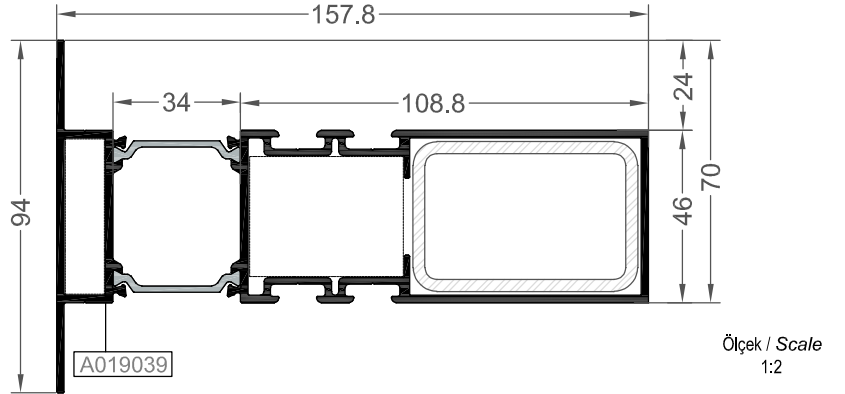

**AREWG4008		
	<b>AĞIRLIK</b> WEIGHT (kg/m)	3,148
	<b>MALZEME</b> MATERIAL	Alüminyum
	<b>UZUNLUK</b> LENGTH (m)	6
	<b>Jx</b> (cm <sup>2</sup> )	
	<b>Jy</b> (cm <sup>2</sup> )	
	<b>KESİT No</b> SECTION No.	6



\*\*Kalıp aktif değildir. Sipariş üzerine yapılacaktır.  
The die is not active. It will be produced by order.

Nr	 Profil Kodu Profile No (6,000mm.)	KESİM ÖLÇÜSÜ CUTTING SIZE	 AKS. KODU ACS. CODE (Adet Kodu)	
AREWG4001	A019039	REWG6001 (A019018)	41,5 mm	05.REW.01
	A019011	REWG6002 (A019019)	32,0 mm	05.REW.10

## DESTEK PROFİLLERİ SUPPORT PROFILES

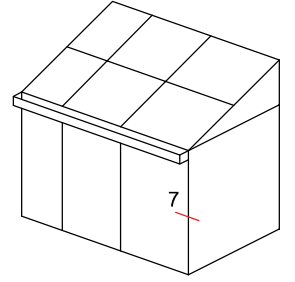

** AREWG4004	
 <b>AĞIRLIK</b> WEIGHT (kg/m)	4,156
 <b>MALZEME</b> MATERIAL	Alüminyum
 <b>UZUNLUK</b> LENGTH (m)	6
 <b>Jx</b> (cm <sup>4</sup> )	
 <b>Jy</b> (cm <sup>4</sup> )	
 <b>KESİT No</b> SECTION No.	7

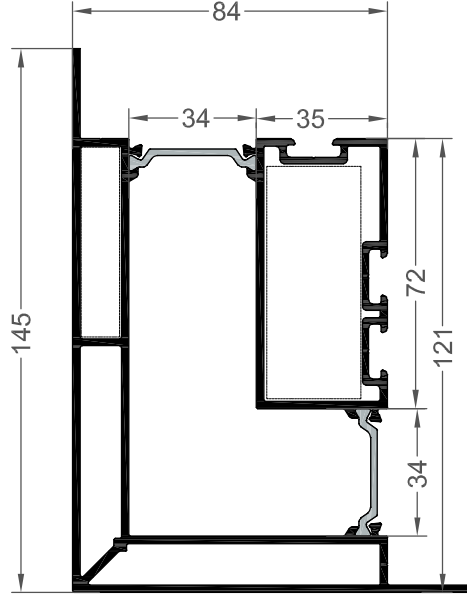

Ölçek / Scale  
1:2



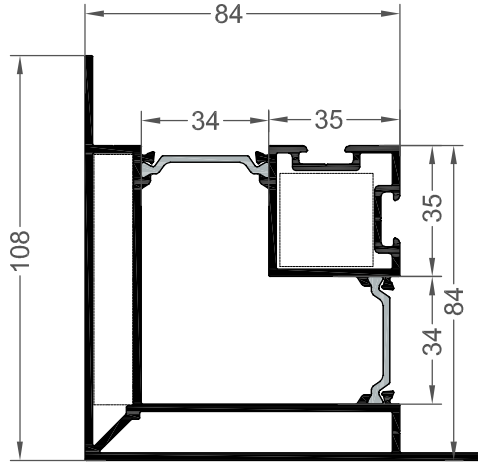



** AREWG4003	
 <b>AĞIRLIK</b> WEIGHT (kg/m)	3,300
 <b>MALZEME</b> MATERIAL	Alüminyum
 <b>UZUNLUK</b> LENGTH (m)	6
 <b>Jx</b> (cm <sup>4</sup> )	
 <b>Jy</b> (cm <sup>4</sup> )	
 <b>KESİT No</b> SECTION No.	7



Ölçek / Scale  
1:2

\*\*Kalıp aktif değildir. Sipariş üzerine yapılacaktır.  
The die is not active. It will be produced by order.

## DESTEK PROFİLLERİ SUPPORT PROFILES

**AREWG4004		
	<b>AĞIRLIK</b> WEIGHT (kg/m)	4,156
	<b>MALZEME</b> MATERIAL	Alüminyum
	<b>UZUNLUK</b> LENGTH (m)	6
	<b>Jx</b> (cm <sup>4</sup> )	
	<b>Jy</b> (cm <sup>4</sup> )	
	<b>KESİT No</b> SECTION No.	7

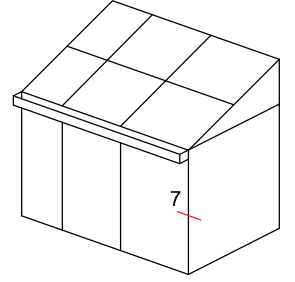
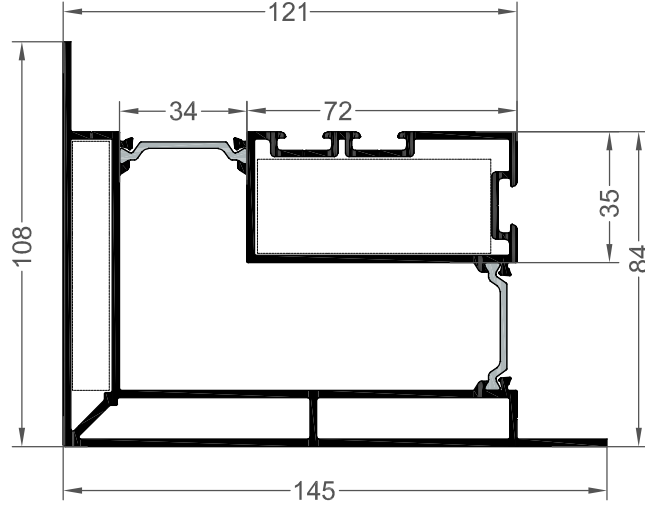

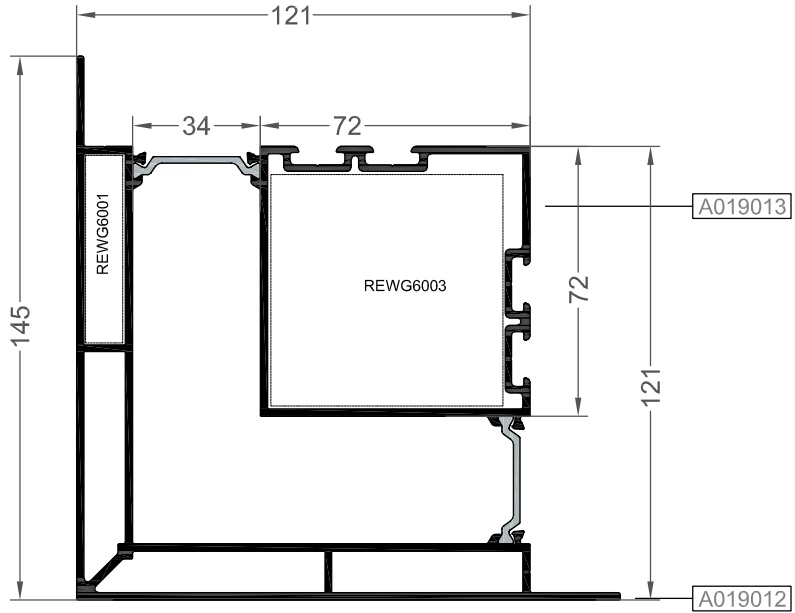

Ölçek / Scale  
1:2

AREWG4002		
	<b>AĞIRLIK</b> WEIGHT (kg/m)	5,154
	<b>MALZEME</b> MATERIAL	Alüminyum
	<b>UZUNLUK</b> LENGTH (m)	6
	<b>Jx</b> (cm <sup>4</sup> )	
	<b>Jy</b> (cm <sup>4</sup> )	
	<b>KESİT No</b> SECTION No.	7







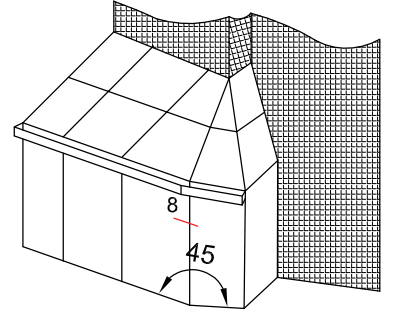

Ölçek / Scale  
1:2

\*\*Kalıp aktif değildir. Sipariş üzerine yapılacaktır.  
The die is not active. It will be produced by order.





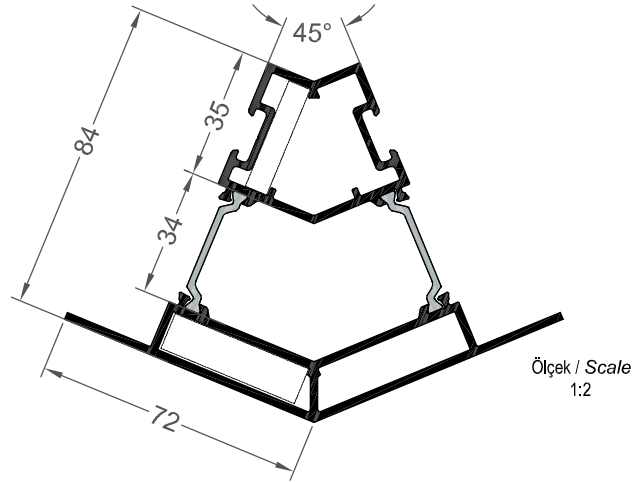

Nr		Profil Kodu Profile No (6.000mm.)	KESİM ÖLÇÜSÜ CUTTING SIZE		AKS. KODU ACS. CODE (Adet Kodu)
AREWG4002	A019012	REWG6001 (A019018)	50,5 mm	05.REW.02	
	A019013	REWG6003 (A019020)	62,8 mm	05.REW.15	

## DESTEK PROFİLLERİ SUPPORT PROFILES



** AREWG4006		
	<b>AĞIRLIK</b> WEIGHT (kg/m)	2,659
	<b>MALZEME</b> MATERIAL	Alüminyum
	<b>UZUNLUK</b> LENGTH (m)	6
	<b>Jx</b> (cm <sup>4</sup> )	
	<b>Jy</b> (cm <sup>4</sup> )	
	<b>KESİT No</b> SECTION No.	8



** AREWG4005		
	<b>AĞIRLIK</b> WEIGHT (kg/m)	3,869
	<b>MALZEME</b> MATERIAL	Alüminyum
	<b>UZUNLUK</b> LENGTH (m)	6
	<b>Jx</b> (cm <sup>4</sup> )	
	<b>Jy</b> (cm <sup>4</sup> )	
	<b>KESİT No</b> SECTION No.	8

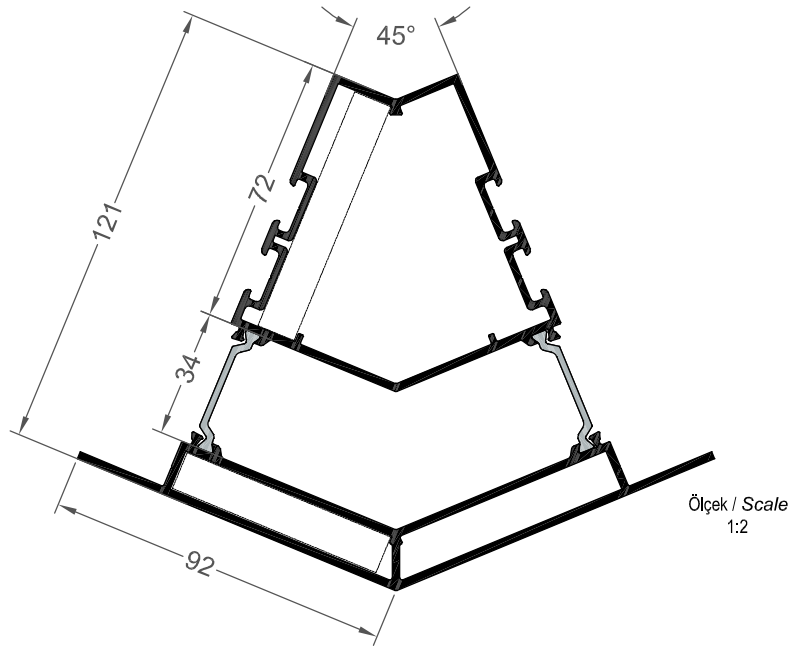

\*\*Kalıp aktif değildir. Sipariş üzerine yapılacaktır.  
The die is not active. It will be produced by order.

# PROFİLLER PROFILES

# REWG50



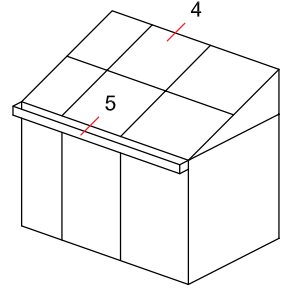

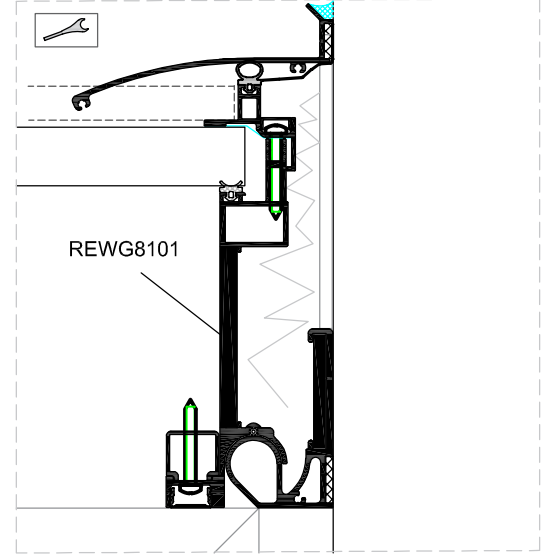
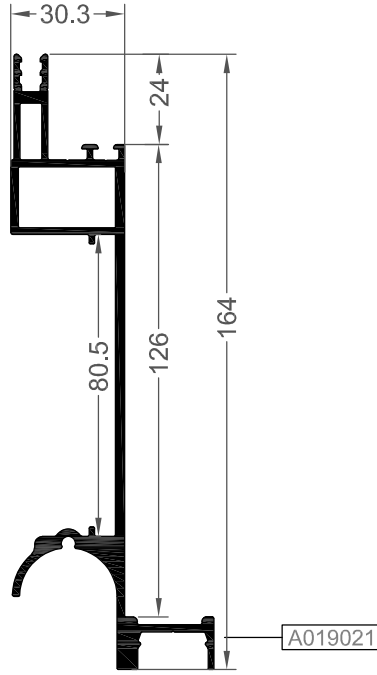

KRIŞ ALT VE ÜST BAĞLANTI PROFİLLERİ  
SUPPORTS



REWG8101		
 <b>AĞIRLIK</b> WEIGHT (kg/m)	2,274	
 <b>MALZEME</b> MATERIAL	Alüminyum	
 <b>UZUNLUK</b> LENGTH (m)	6	
 <b>Jx</b> (cm <sup>4</sup> )		
 <b>Jy</b> (cm <sup>4</sup> )		
 <b>KESİT No</b> SECTION No.	4	



Ölçek / Scale  
1:2



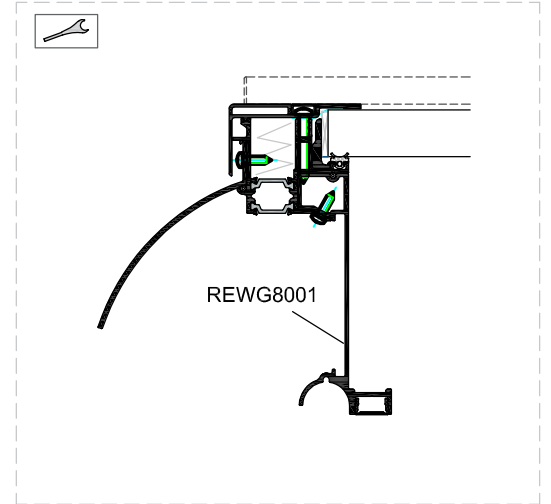
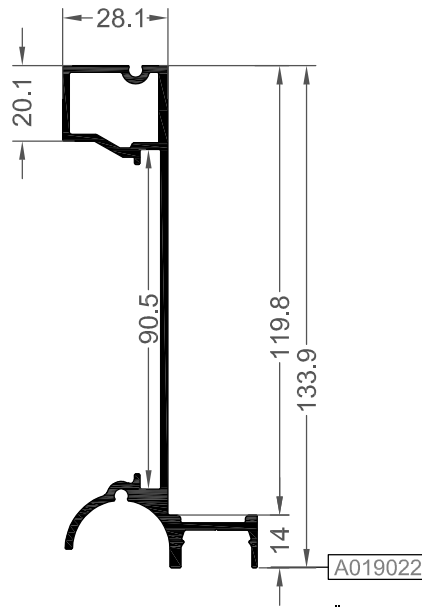

REWG8001		
 <b>AĞIRLIK</b> WEIGHT (kg/m)	1,659	
 <b>MALZEME</b> MATERIAL	Alüminyum	
 <b>UZUNLUK</b> LENGTH (m)	6	
 <b>Jx</b> (cm <sup>4</sup> )		
 <b>Jy</b> (cm <sup>4</sup> )		
 <b>KESİT No</b> SECTION No.	5	

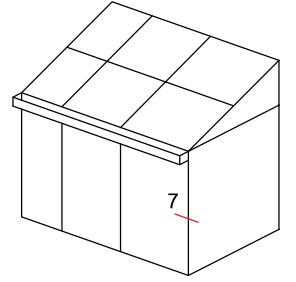

Ölçek / Scale  
1:2



## YAĞMUR BORUSU İNİŞ KAPAĞI DOWNPIPE CLADDING

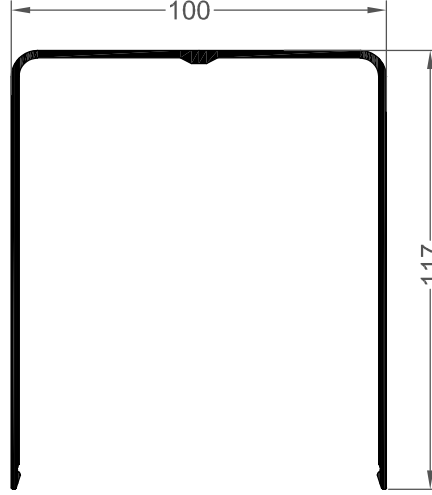

**REWG8402		
	<b>AĞIRLIK</b> WEIGHT (kg/m)	1,782
	<b>MALZEME</b> MATERIAL	Alüminyum
	<b>UZUNLUK</b> LENGTH (m)	6
	<b>Jx</b> (cm <sup>4</sup> )	
	<b>Jy</b> (cm <sup>4</sup> )	
	<b>KESİT No</b> SECTION No.	7



Ölçek / Scale  
1:2

**REWG8401		
	<b>AĞIRLIK</b> WEIGHT (kg/m)	0,795
	<b>MALZEME</b> MATERIAL	Alüminyum
	<b>UZUNLUK</b> LENGTH (m)	6
	<b>Jx</b> (cm <sup>4</sup> )	
	<b>Jy</b> (cm <sup>4</sup> )	
	<b>KESİT No</b> SECTION No.	7

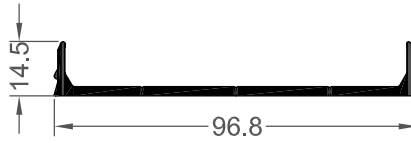

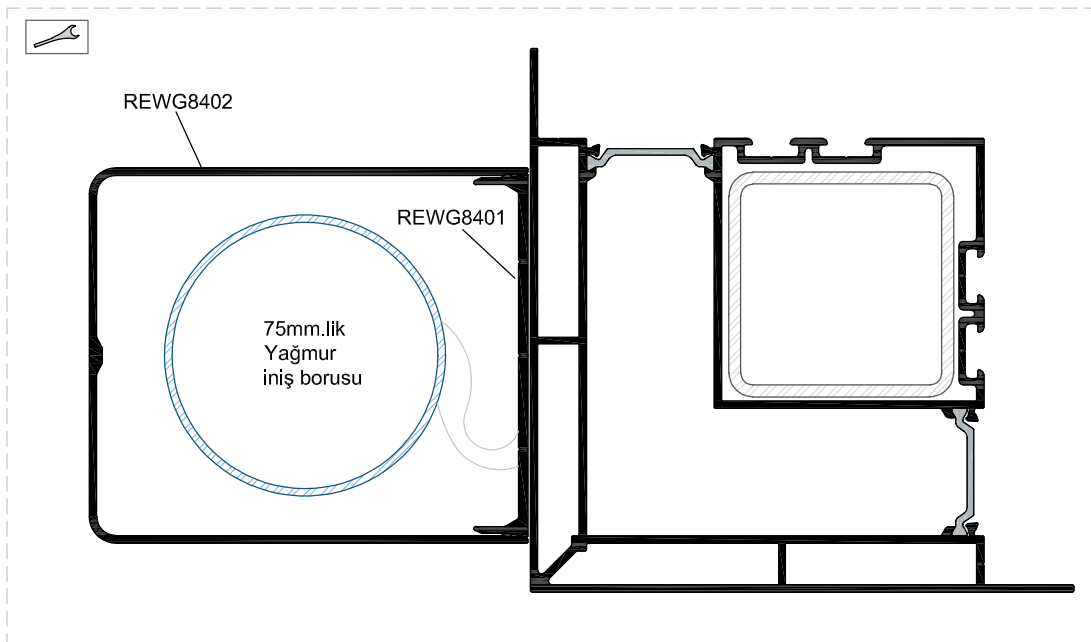

Ölçek / Scale  
1:2

\*\*Kalıp aktif değildir. Sipariş üzerine yapılacaktır.  
The die is not active. It will be produced by order.

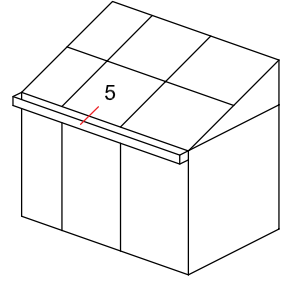

YAĞMUR BORUSU İNİŞ KAPAĞI  
DOWNPIPE CLADDING



AREWG5101		
	<b>AĞIRLIK</b> WEIGHT (kg/m)	4,014
	<b>MALZEME</b> MATERIAL	Alüminyum
	<b>UZUNLUK</b> LENGTH (m)	6
	<b>Jx</b> (cm <sup>4</sup> )	
	<b>Jy</b> (cm <sup>4</sup> )	
	<b>KESİT No</b> SECTION No.	5

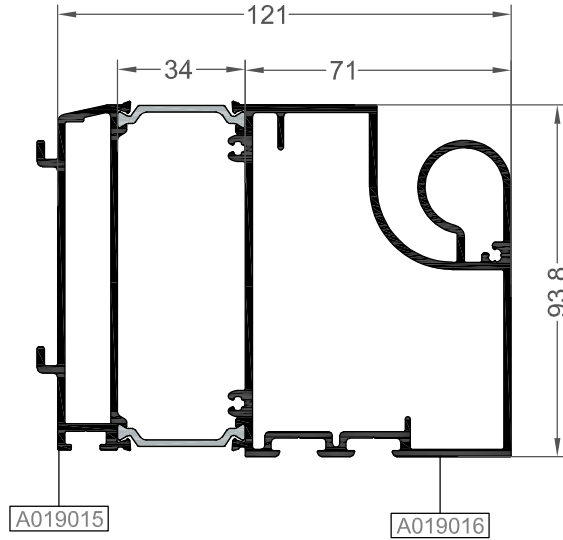

** AREWG5102		
	<b>AĞIRLIK</b> WEIGHT (kg/m)	3,533
	<b>MALZEME</b> MATERIAL	Alüminyum
	<b>UZUNLUK</b> LENGTH (m)	6
	<b>Jx</b> (cm <sup>4</sup> )	
	<b>Jy</b> (cm <sup>4</sup> )	
	<b>KESİT No</b> SECTION No.	5

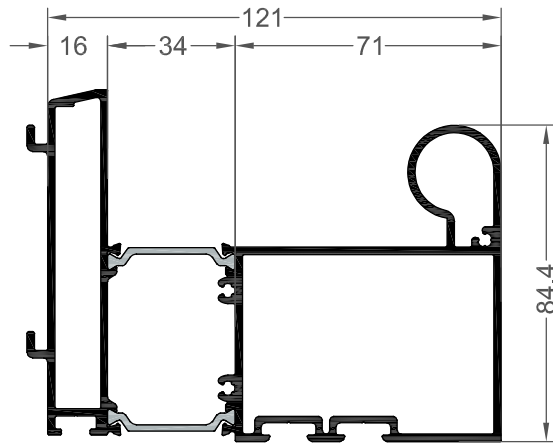

\*\*Kalıp aktif değildir. Sipariş üzerine yapılacaktır.  
The die is not active. It will be produced by order.





# PROFİLLER PROFILES

# REWG50

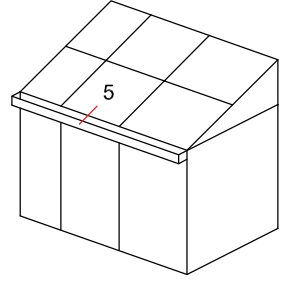
SU OLUĞU  
GUTTER



REWG 5001		
 <b>AĞIRLIK</b> WEIGHT (kg/m)		2,720
 <b>MALZEME</b> MATERIAL		Alüminyum
 <b>UZUNLUK</b> LENGTH (m)		6
 <b>Jx</b> (cm <sup>4</sup> )		
 <b>Jy</b> (cm <sup>4</sup> )		
 <b>KESİT No</b> SECTION No.		5

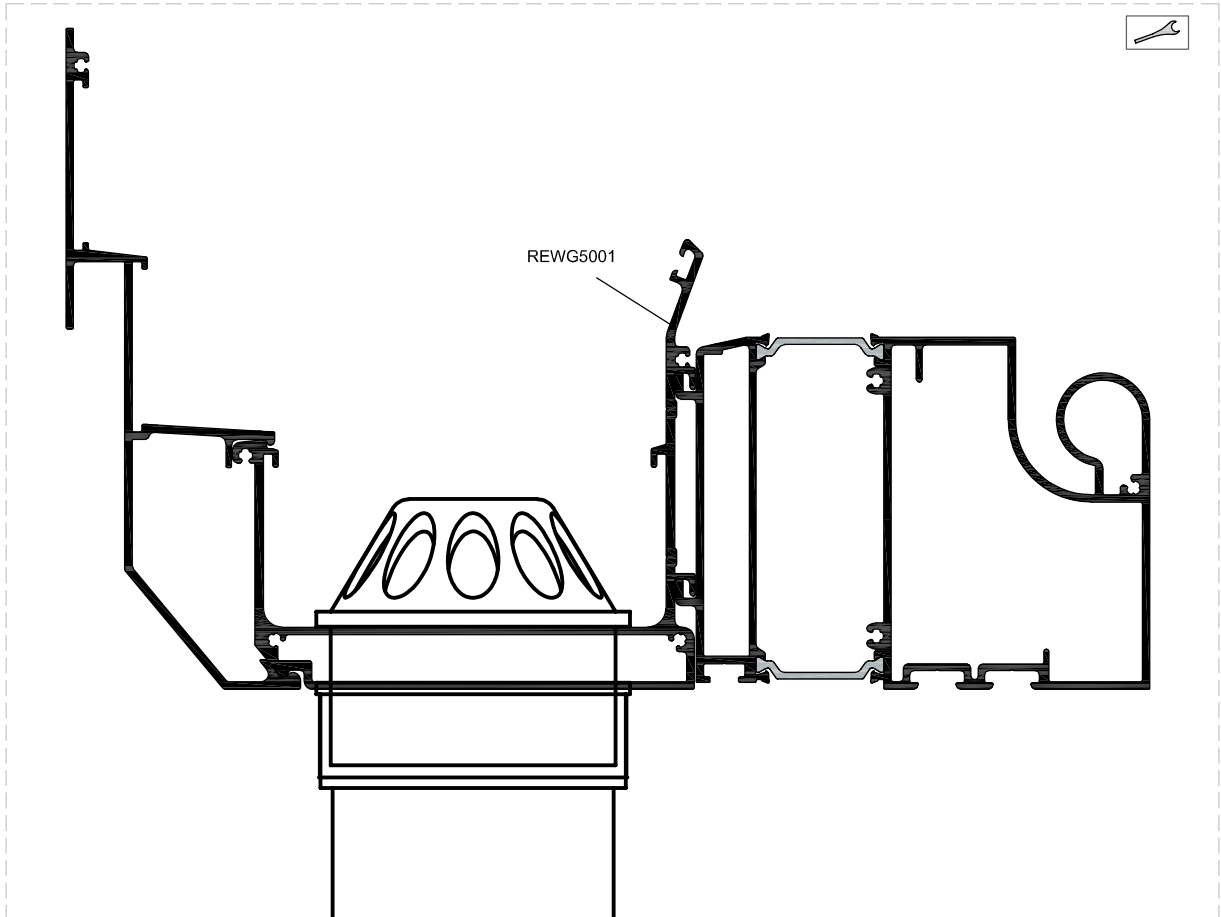
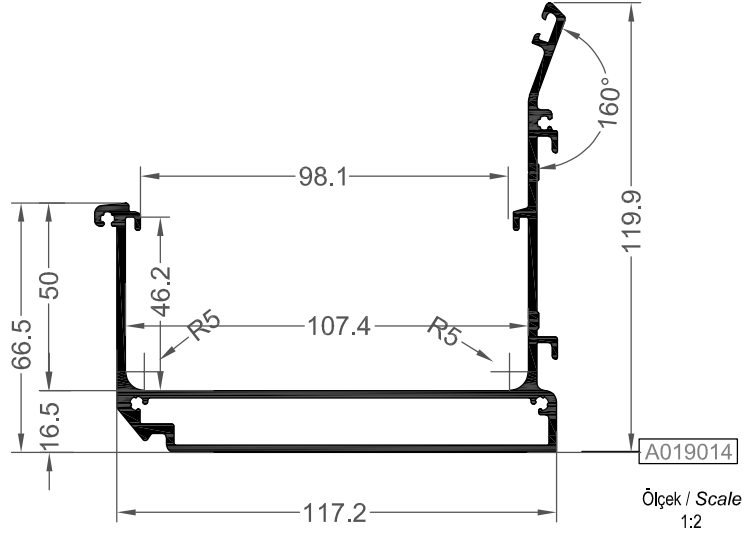





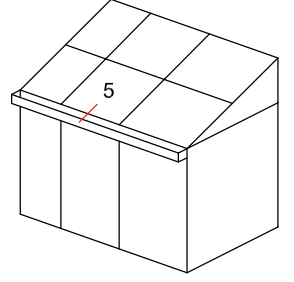

# PROFİLLER PROFILES

# REWG50

BAĞLANTI PROFİLLERİ  
CONNECTOR PROFILES



**REWG 8301		
	<b>AĞIRLIK</b> WEIGHT (kg/m)	1,106
	<b>MALZEME</b> MATERIAL	Alüminyum
	<b>UZUNLUK</b> LENGTH (m)	6
	<b>Jx</b> (cm <sup>4</sup> )	
	<b>Jy</b> (cm <sup>4</sup> )	
	<b>KESİT No</b> SECTION No.	5

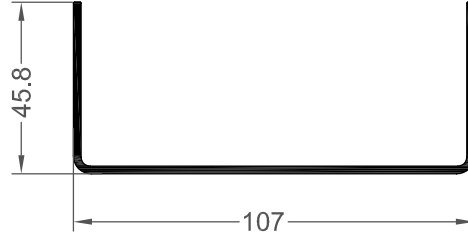

Ölçek / Scale  
1:2

\*\*Kalıp aktif değildir. Sipariş üzerine yapılacaktır.  
The die is not active. It will be produced by order.

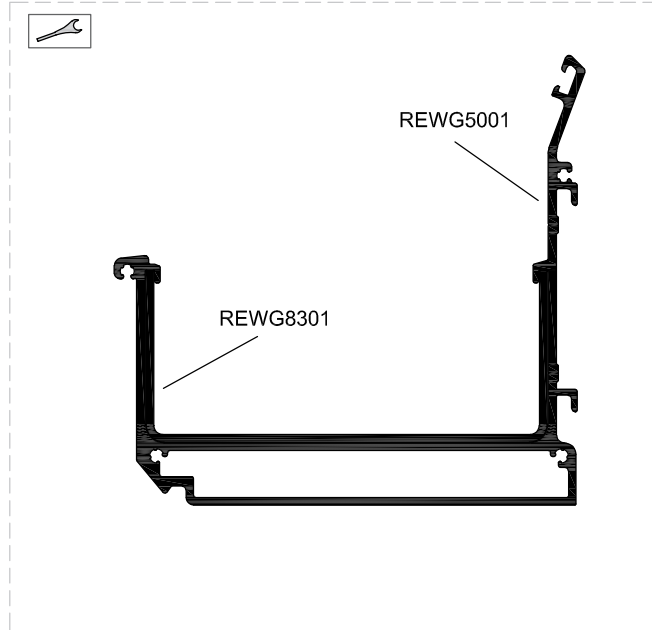

## OLUK EK PROFİLLERİ GUTTER ADDITIONAL PROFILES

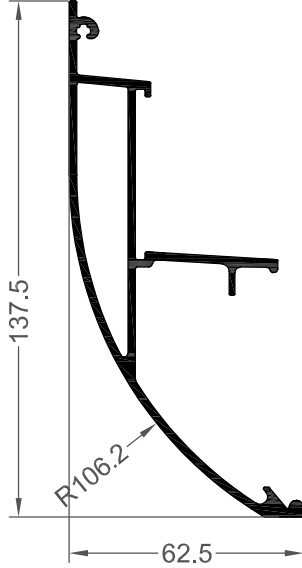

Ölçek / Scale  
1:2

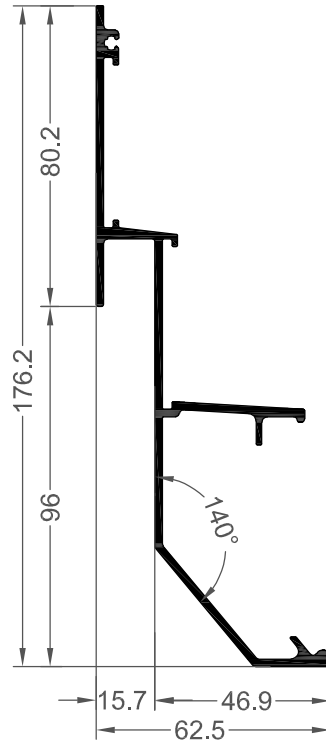

Ölçek / Scale  
1:2

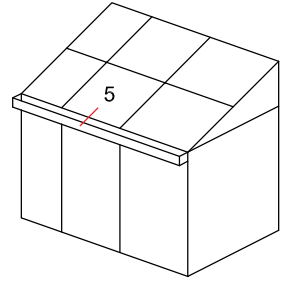

**REWG 5202		
	<b>AĞIRLIK</b> WEIGHT (kg/m)	1,838
	<b>MALZEME</b> MATERIAL	Alüminyum
	<b>UZUNLUK</b> LENGTH (m)	6
	<b>Jx</b> (cm <sup>4</sup> )	
	<b>Jy</b> (cm <sup>4</sup> )	
	<b>KESİT No</b> SECTION No.	5





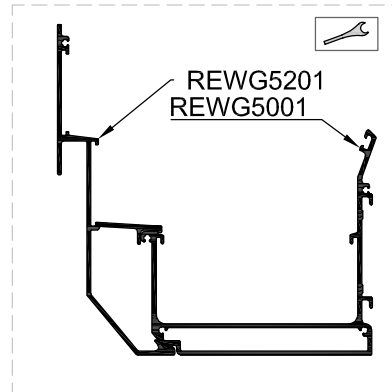
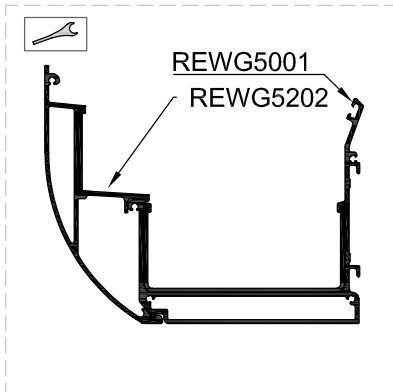

REWG 5201		
	<b>AĞIRLIK</b> WEIGHT (kg/m)	1,743
	<b>MALZEME</b> MATERIAL	Alüminyum
	<b>UZUNLUK</b> LENGTH (m)	6
	<b>Jx</b> (cm <sup>4</sup> )	
	<b>Jy</b> (cm <sup>4</sup> )	
	<b>KESİT No</b> SECTION No.	5

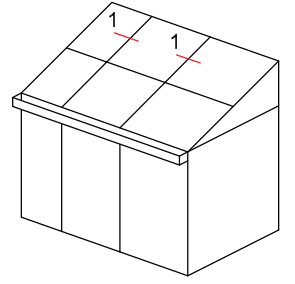
\*\*Kalıp aktif değildir. Sipariş üzerine yapılacaktır.  
The die is not active. It will be produced by order.



## AYDINLATMA KAPAĞI LIGHTING COVER



**REWG 7001		
	<b>AĞIRLIK</b> WEIGHT (kg/m)	0,397
	<b>MALZEME</b> MATERIAL	Alüminyum
	<b>UZUNLUK</b> LENGTH (m)	6
	<b>Jx</b> (cm <sup>2</sup> )	
	<b>Jy</b> (cm <sup>2</sup> )	
	<b>KESİT No</b> SECTION No.	1

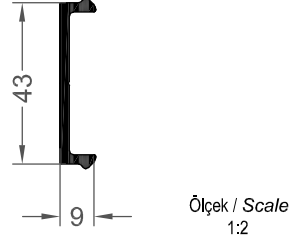

**REWG 7002		
	<b>AĞIRLIK</b> WEIGHT (kg/m)	1,011
	<b>MALZEME</b> MATERIAL	Alüminyum
	<b>UZUNLUK</b> LENGTH (m)	6
	<b>Jx</b> (cm <sup>2</sup> )	
	<b>Jy</b> (cm <sup>2</sup> )	
	<b>KESİT No</b> SECTION No.	1

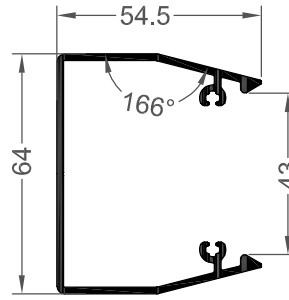

\*\*Kalıp aktif değildir. Sipariş üzerine yapılacaktır.  
The die is not active. It will be produced by order.

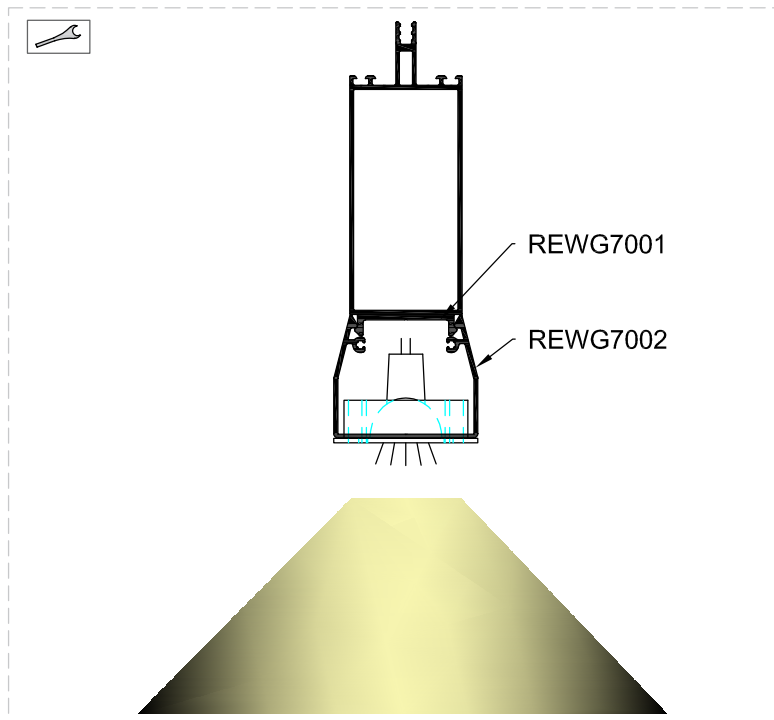

## T BAĞLANTI PROFİLLERİ T CLEAT PROFILES

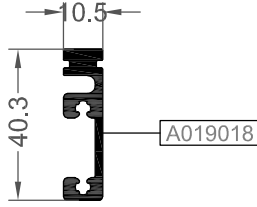

Ölçek / Scale  
1:2

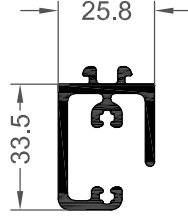

Ölçek / Scale  
1:2

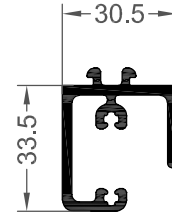

Ölçek / Scale  
1:2

REWG 6001		
	<b>AĞIRLIK</b> WEIGHT (kg/m)	0,580
	<b>MALZEME</b> MATERIAL	Alüminyum
	<b>UZUNLUK</b> LENGTH (m)	6
	<b>Jx</b> (cm <sup>4</sup> )	
	<b>Jy</b> (cm <sup>4</sup> )	
	<b>KESİT No</b> SECTION No.	

**REWG 6005		
	<b>AĞIRLIK</b> WEIGHT (kg/m)	0,832
	<b>MALZEME</b> MATERIAL	Alüminyum
	<b>UZUNLUK</b> LENGTH (m)	6
	<b>Jx</b> (cm <sup>4</sup> )	
	<b>Jy</b> (cm <sup>4</sup> )	
	<b>KESİT No</b> SECTION No.	

**REWG 6006		
	<b>AĞIRLIK</b> WEIGHT (kg/m)	0,865
	<b>MALZEME</b> MATERIAL	Alüminyum
	<b>UZUNLUK</b> LENGTH (m)	6
	<b>Jx</b> (cm <sup>4</sup> )	
	<b>Jy</b> (cm <sup>4</sup> )	
	<b>KESİT No</b> SECTION No.	

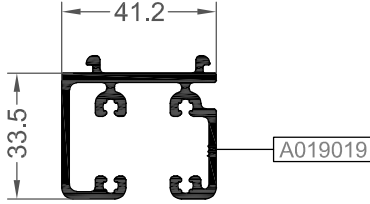

Ölçek / Scale  
1:2

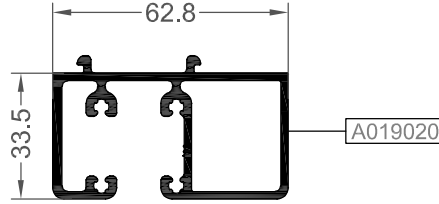

Ölçek / Scale  
1:2

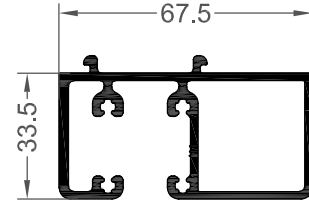

Ölçek / Scale  
1:2





REWG 6002		
	<b>AĞIRLIK</b> WEIGHT (kg/m)	1,116
	<b>MALZEME</b> MATERIAL	Alüminyum
	<b>UZUNLUK</b> LENGTH (m)	6
	<b>Jx</b> (cm <sup>4</sup> )	
	<b>Jy</b> (cm <sup>4</sup> )	
	<b>KESİT No</b> SECTION No.	

REWG 6003		
	<b>AĞIRLIK</b> WEIGHT (kg/m)	1,453
	<b>MALZEME</b> MATERIAL	Alüminyum
	<b>UZUNLUK</b> LENGTH (m)	6
	<b>Jx</b> (cm <sup>4</sup> )	
	<b>Jy</b> (cm <sup>4</sup> )	
	<b>KESİT No</b> SECTION No.	

**REWG 6004		
	<b>AĞIRLIK</b> WEIGHT (kg/m)	1,504
	<b>MALZEME</b> MATERIAL	Alüminyum
	<b>UZUNLUK</b> LENGTH (m)	6
	<b>Jx</b> (cm <sup>4</sup> )	
	<b>Jy</b> (cm <sup>4</sup> )	
	<b>KESİT No</b> SECTION No.	

\*\*Kalıp aktif değildir. Sipariş üzerine yapılacaktır.  
The die is not active. It will be produced by order.

## BAĞLANTI PROFİLLERİ CONNECTOR PROFILES

**REWG 8305		
 <b>AĞIRLIK</b> WEIGHT (kg/m)		0,678
 <b>MALZEME</b> MATERIAL		Alüminyum
 <b>UZUNLUK</b> LENGTH (m)		6
	<b>Jx</b> (cm <sup>4</sup> )	
	<b>Jy</b> (cm <sup>4</sup> )	
 <b>KESİT No</b> SECTION No.		4

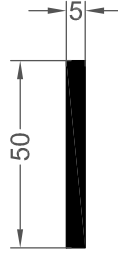

Ölçek / Scale  
1:2

**REWG 8302		
 <b>AĞIRLIK</b> WEIGHT (kg/m)		1,219
 <b>MALZEME</b> MATERIAL		Alüminyum
 <b>UZUNLUK</b> LENGTH (m)		6
	<b>Jx</b> (cm <sup>4</sup> )	
	<b>Jy</b> (cm <sup>4</sup> )	
 <b>KESİT No</b> SECTION No.		5

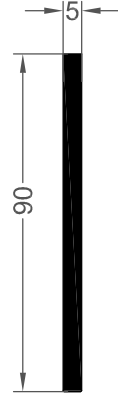



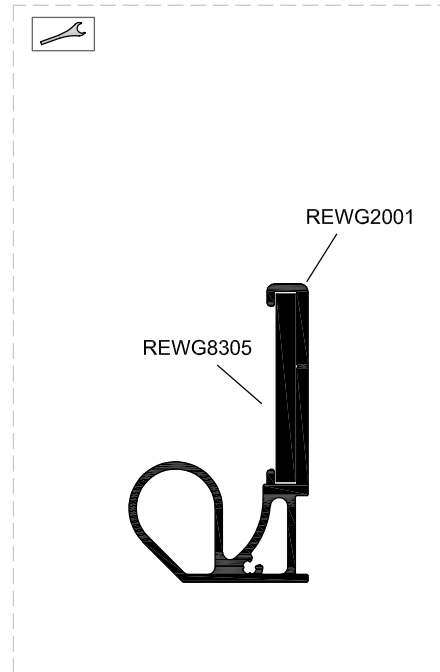
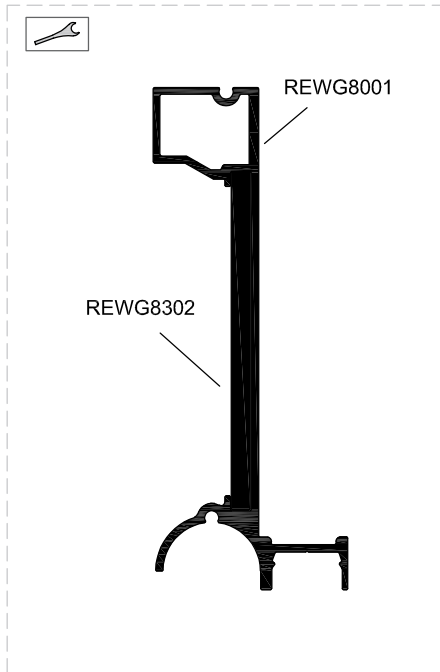

Ölçek / Scale  
1:2

\*\*Kalıp aktif değildir. Sipariş üzerine yapılacaktır.  
The die is not active. It will be produced by order.



## BAĞLANTI PROFİLLERİ CONNECTOR PROFILES

**REWG 8303		
 <b>AĞIRLIK</b> WEIGHT (kg/m)		0,256
 <b>MALZEME</b> MATERIAL		Alüminyum
 <b>UZUNLUK</b> LENGTH (m)		6
	<b>Jx</b> (cm <sup>4</sup> )	
	<b>Jy</b> (cm <sup>4</sup> )	
 <b>KESİT No</b> SECTION No.		5

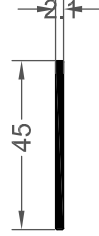

Ölçek / Scale  
1:2

**REWG 8304		
 <b>AĞIRLIK</b> WEIGHT (kg/m)		1,084
 <b>MALZEME</b> MATERIAL		Alüminyum
 <b>UZUNLUK</b> LENGTH (m)		6
	<b>Jx</b> (cm <sup>4</sup> )	
	<b>Jy</b> (cm <sup>4</sup> )	
 <b>KESİT No</b> SECTION No.		4

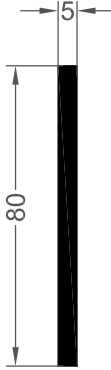



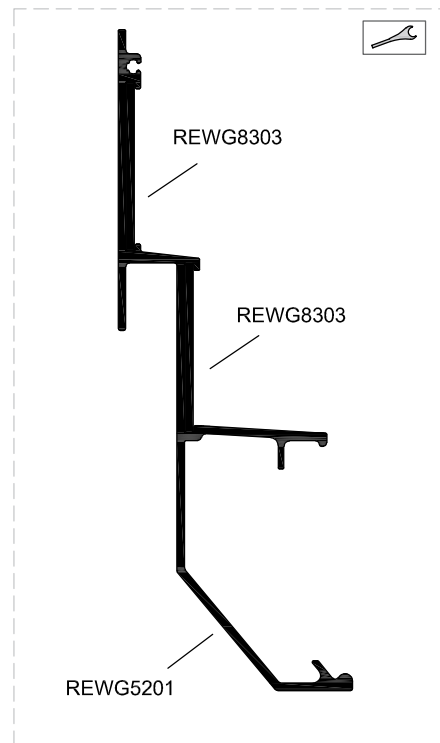
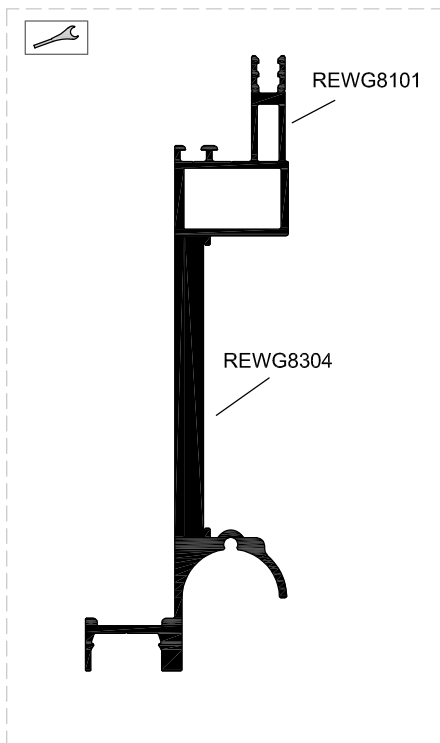

Ölçek / Scale  
1:2





\*\*Kalıp aktif değildir. Sipariş üzerine yapılacaktır.  
The die is not active. It will be produced by order.



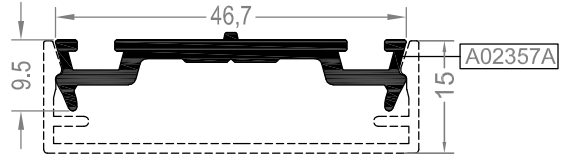



## BASKI KAPAK PROFİLLERİ CAP PROFILES

R50 P 01		
	<b>AĞIRLIK</b> WEIGHT (kg/m)	0,428
	<b>MALZEME</b> MATERIAL	Alüminyum
	<b>UZUNLUK</b> LENGTH (m)	6
	<b>Jx</b> (cm <sup>4</sup> )	
	<b>Jy</b> (cm <sup>4</sup> )	
	<b>KESİT No</b> SECTION No.	1-3

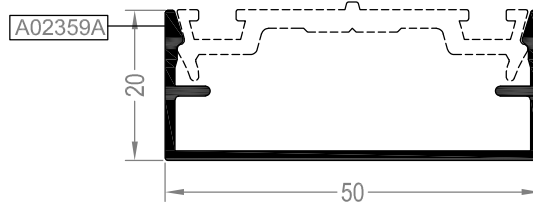

R50 P 03		
	<b>AĞIRLIK</b> WEIGHT (kg/m)	0,360
	<b>MALZEME</b> MATERIAL	Alüminyum
	<b>UZUNLUK</b> LENGTH (m)	6
	<b>Jx</b> (cm <sup>4</sup> )	
	<b>Jy</b> (cm <sup>4</sup> )	
	<b>KESİT No</b> SECTION No.	1-3





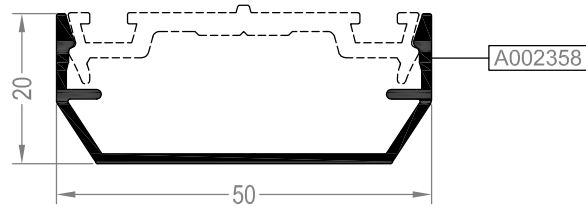



R50 P 02		
	<b>AĞIRLIK</b> WEIGHT (kg/m)	0,325
	<b>MALZEME</b> MATERIAL	Alüminyum
	<b>UZUNLUK</b> LENGTH (m)	6
	<b>Jx</b> (cm <sup>4</sup> )	
	<b>Jy</b> (cm <sup>4</sup> )	
	<b>KESİT No</b> SECTION No.	1-3





## BASKI KAPAK PROFİLLERİ CAP PROFILES

R50 P 15		
	<b>AĞIRLIK</b> WEIGHT (kg/m)	0,323
	<b>MALZEME</b> MATERIAL	Alüminyum
	<b>UZUNLUK</b> LENGTH (m)	6
	<b>Jx</b> (cm <sup>4</sup> )	
	<b>Jy</b> (cm <sup>4</sup> )	
	<b>KESİT No</b> SECTION No.	1-3

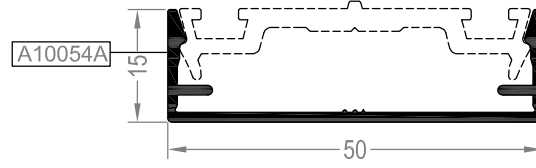



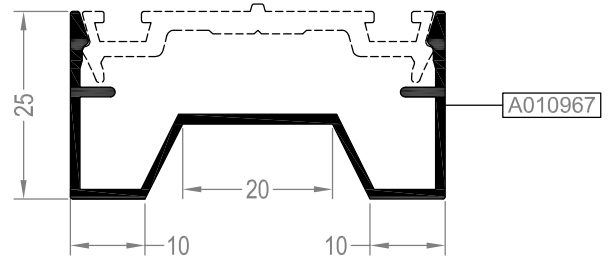

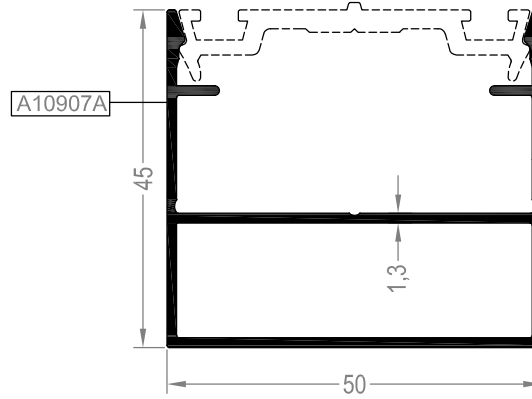

R50 P 29		
	<b>AĞIRLIK</b> WEIGHT (kg/m)	0,424
	<b>MALZEME</b> MATERIAL	Alüminyum
	<b>UZUNLUK</b> LENGTH (m)	6
	<b>Jx</b> (cm <sup>4</sup> )	
	<b>Jy</b> (cm <sup>4</sup> )	
	<b>KESİT No</b> SECTION No.	1-3



R50 P 27		
	<b>AĞIRLIK</b> WEIGHT (kg/m)	0,707
	<b>MALZEME</b> MATERIAL	Alüminyum
	<b>UZUNLUK</b> LENGTH (m)	6
	<b>Jx</b> (cm <sup>4</sup> )	
	<b>Jy</b> (cm <sup>4</sup> )	
	<b>KESİT No</b> SECTION No.	1-3



## BASKI KAPAK PROFİLLERİ CAP PROFILES

R50 P 16		
	<b>AĞIRLIK</b> WEIGHT (kg/m)	0,268
	<b>MALZEME</b> MATERIAL	Alüminyum
	<b>UZUNLUK</b> LENGTH (m)	6
	<b>Jx</b> (cm <sup>4</sup> )	
	<b>Jy</b> (cm <sup>4</sup> )	
	<b>KESİT No</b> SECTION No.	1-3

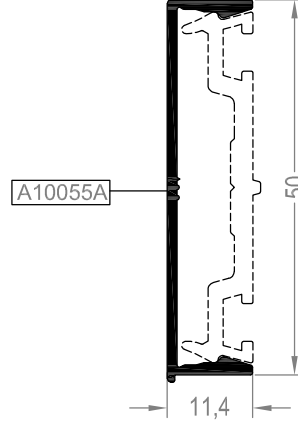

R50 P 20		
	<b>AĞIRLIK</b> WEIGHT (kg/m)	0,248
	<b>MALZEME</b> MATERIAL	Alüminyum
	<b>UZUNLUK</b> LENGTH (m)	6
	<b>Jx</b> (cm <sup>4</sup> )	
	<b>Jy</b> (cm <sup>4</sup> )	
	<b>KESİT No</b> SECTION No.	1-3

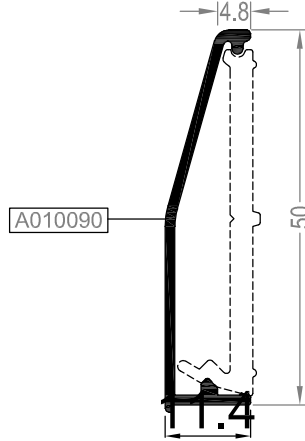

R50 P 19		
	<b>AĞIRLIK</b> WEIGHT (kg/m)	0,419
	<b>MALZEME</b> MATERIAL	Alüminyum
	<b>UZUNLUK</b> LENGTH (m)	6
	<b>Jx</b> (cm <sup>4</sup> )	
	<b>Jy</b> (cm <sup>4</sup> )	
	<b>KESİT No</b> SECTION No.	1-3

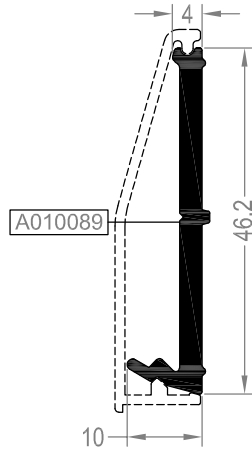

MİMARİ KATALOG  
ARCHITECTURAL CATALOGUE

Alüminyum Kapı Pencere ve Giydirme Cephe Sistemleri  
Aluminium Window Doors and Facade Systems

# REWVG50

YALITIMLI KIS BAHÇESİ SİSTEMİ  
THERMO WINTERGARTEN SYSTEM

**DETAYLAR**

**DETAILS**

126MM MULLION İÇİN OLUK SAÇAK DETAYI  
126MM RAFTER DEPTH EAVES DETAIL

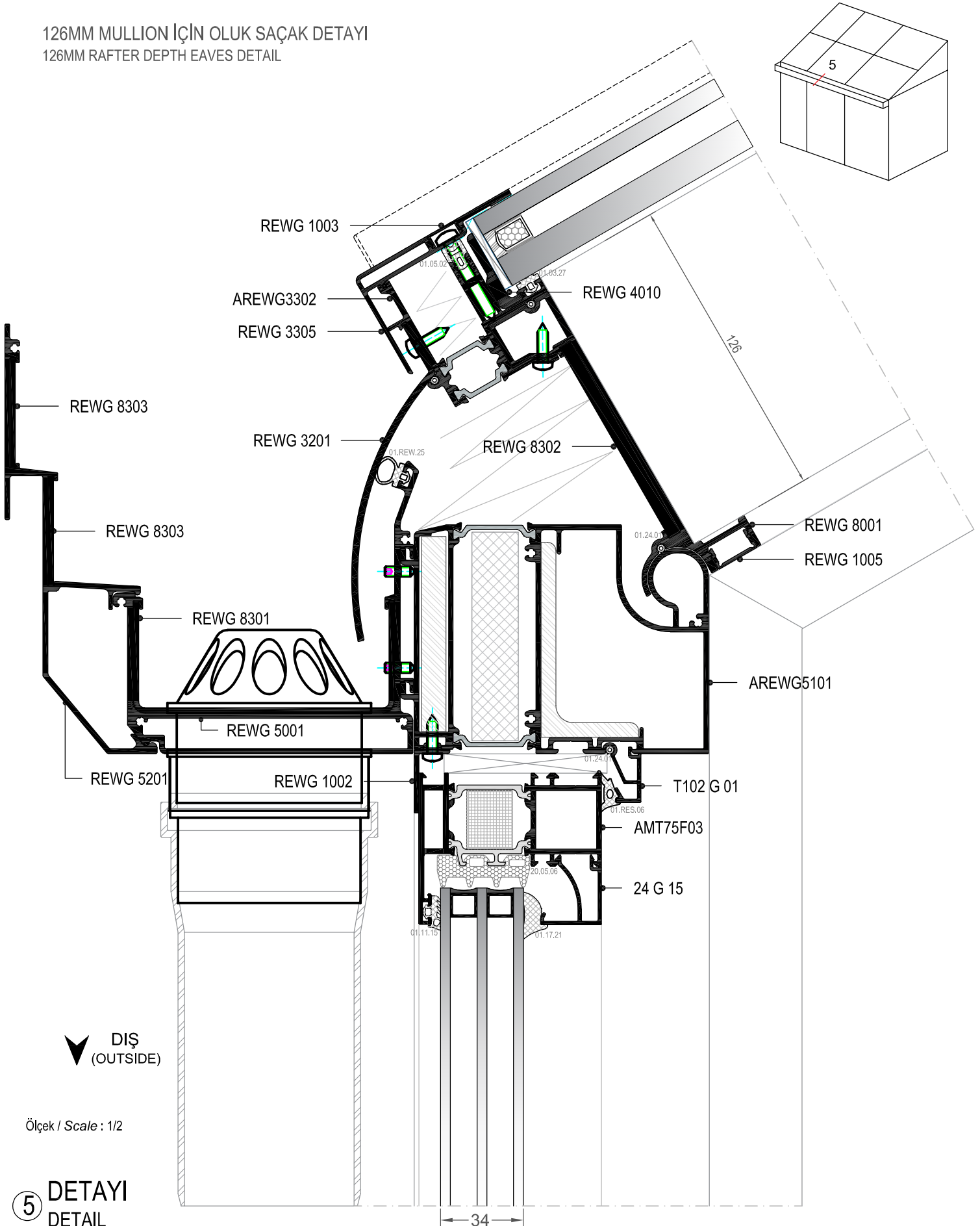

5 DETAYI  
DETAIL

106MM MULLION İÇİN OLUK SAÇAK DETAYI  
106MM RAFTER DEPTH EAVES DETAIL

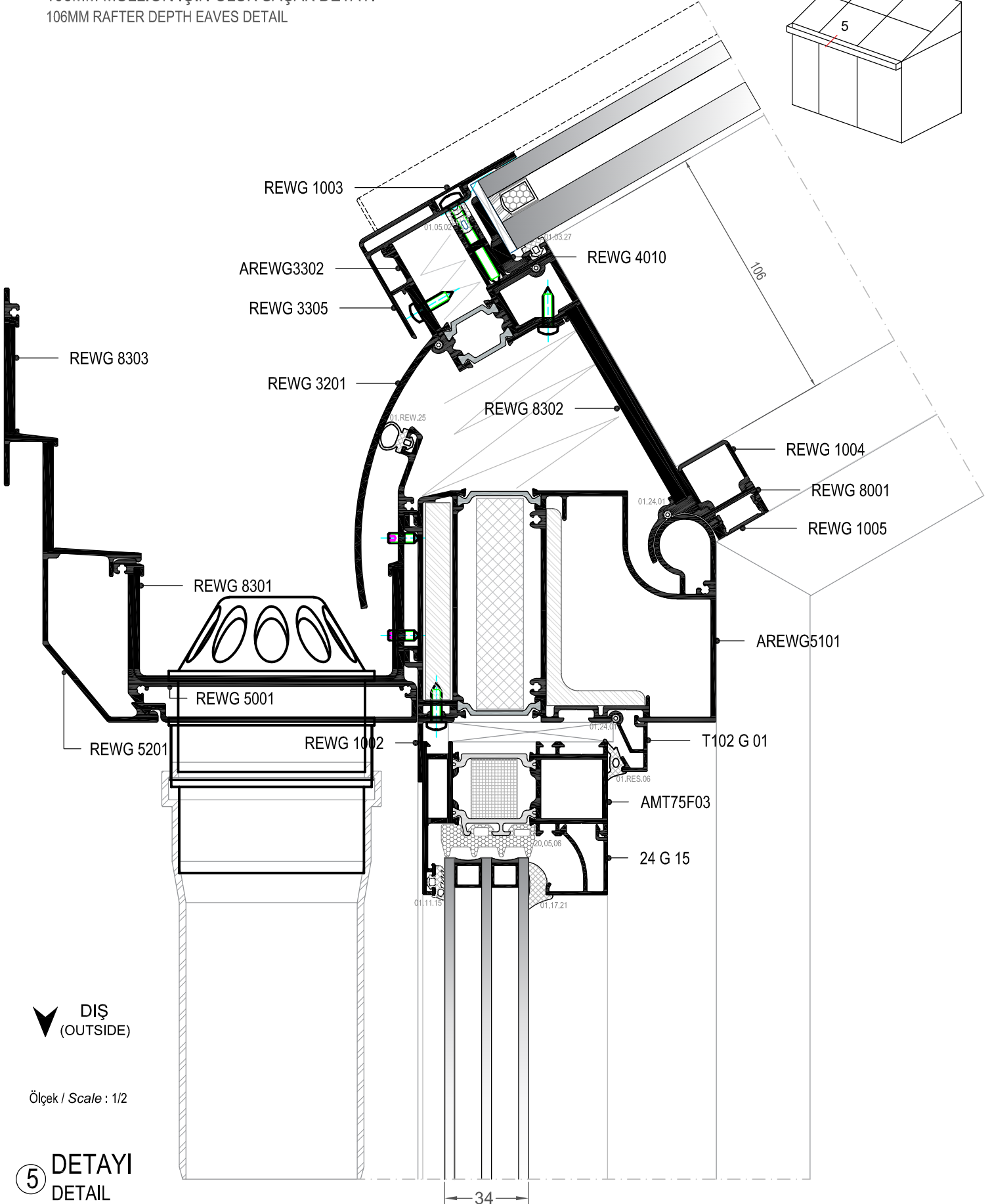
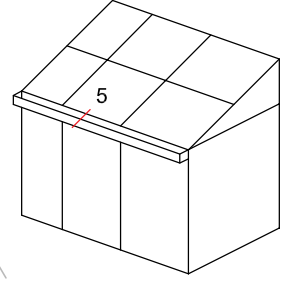

126MM MULLION İÇİN OLUK SAÇAK DETAYI  
126MM RAFTER DEPTH EAVES DETAIL

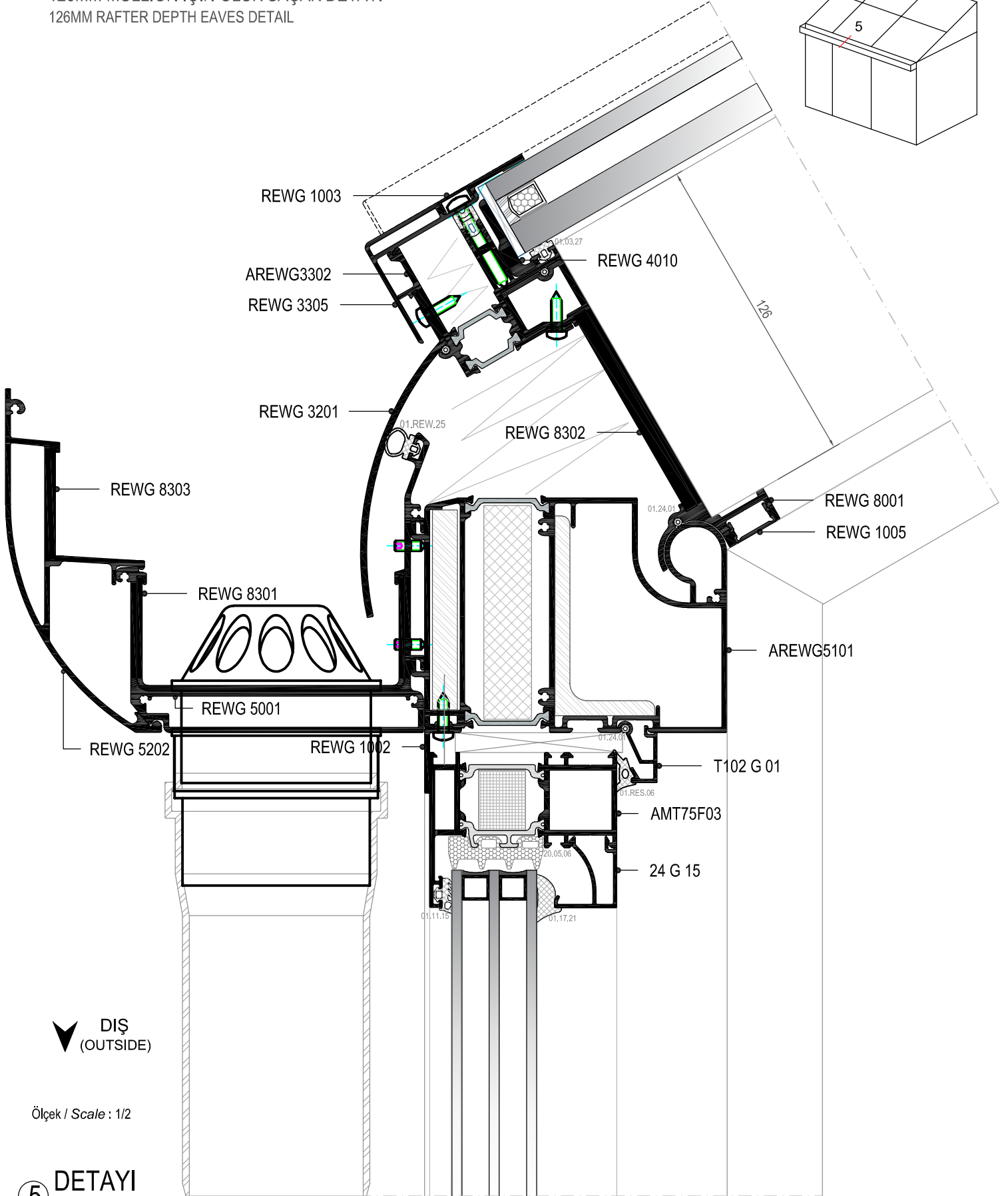
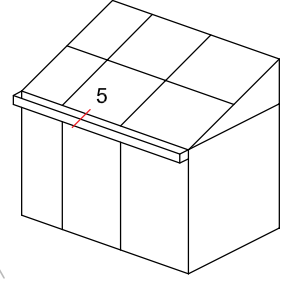

5 DETAYI  
DETAIL

# DETAYLAR DETAILS

# REWG50

126MM MULLION İÇİN EKONOMİK OLUK SAÇAK DETAYI  
126MM RAFTER DEPTH ECO EAVES DETAIL

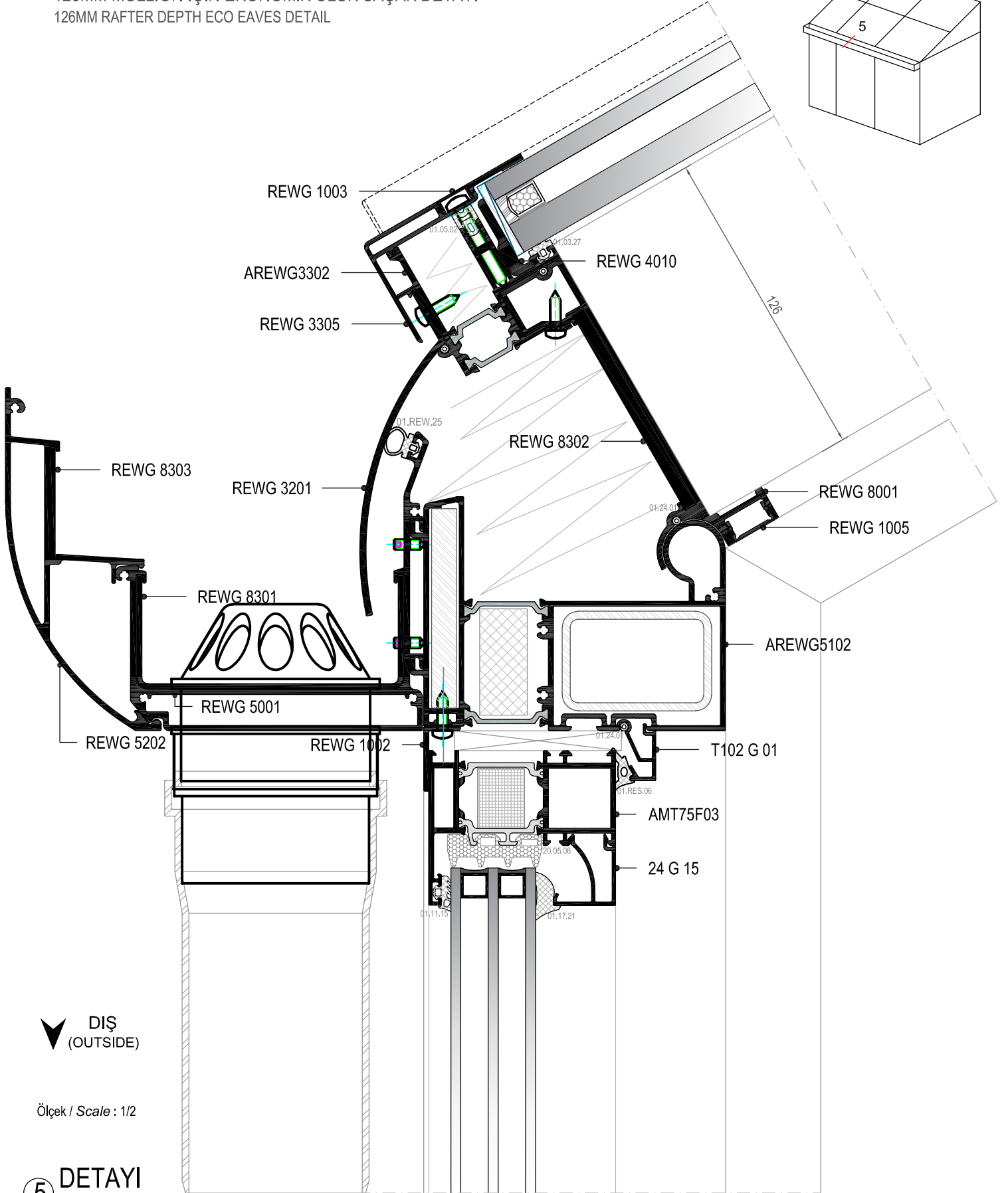
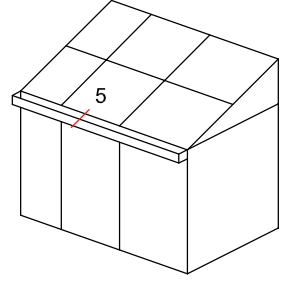

▼ DIŞ  
(OUTSIDE)

Ölçek / Scale : 1/2

5 DETAYI  
DETAIL

126MM MULLION İÇİN KAPAKSIZ OLUK SAÇAK DETAYI  
126MM RAFTER DEPTH WITHOUT COVER EAVES DETAIL

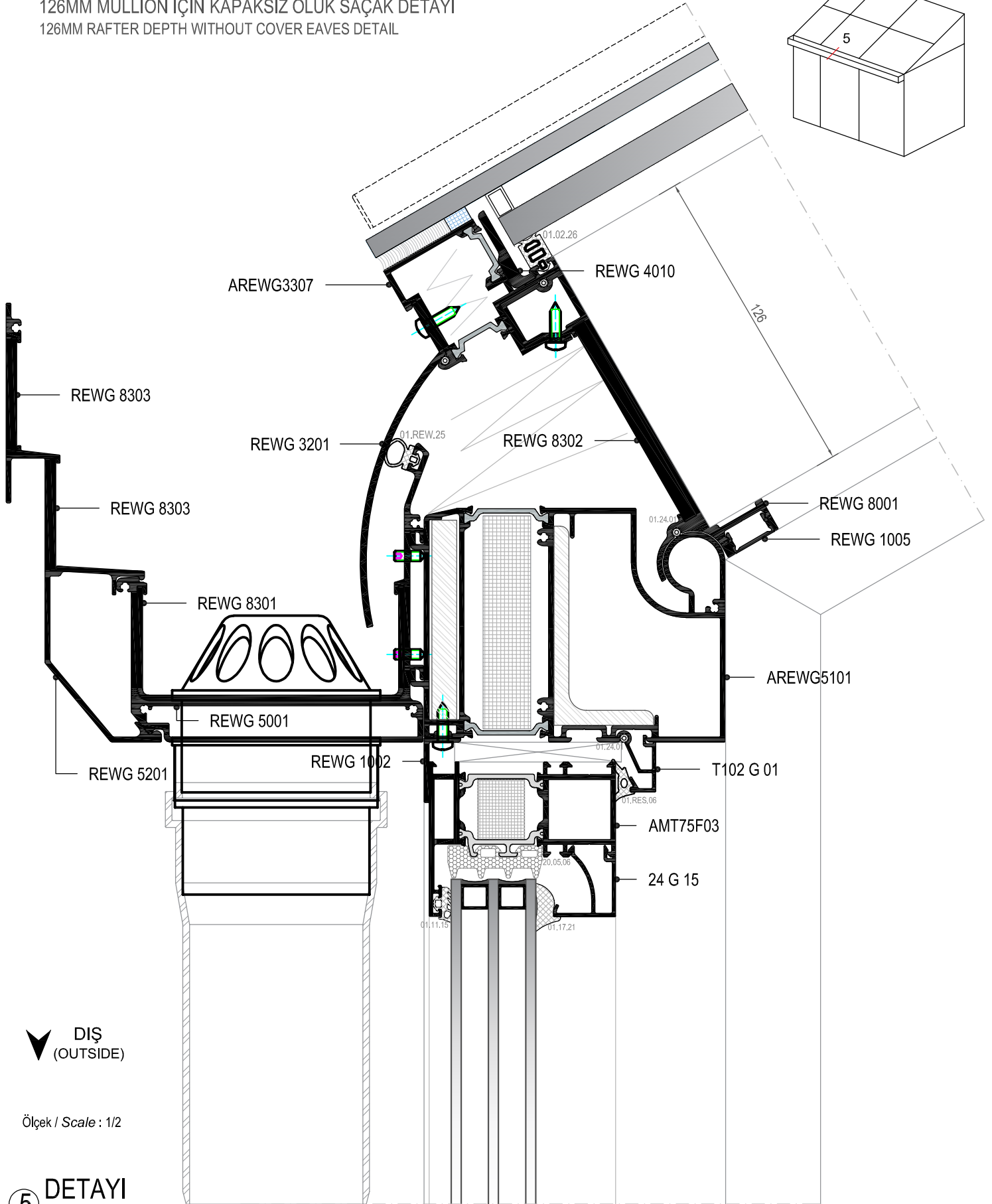
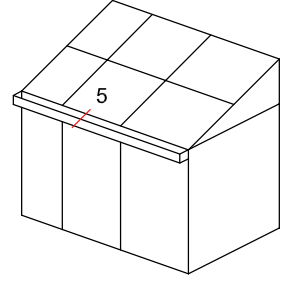

▼ DIŞ  
(OUTSIDE)

Ölçek / Scale : 1/2

5 DETAYI  
DETAIL



## YATAY KAYIT DETAYI TRANSOM DETAIL

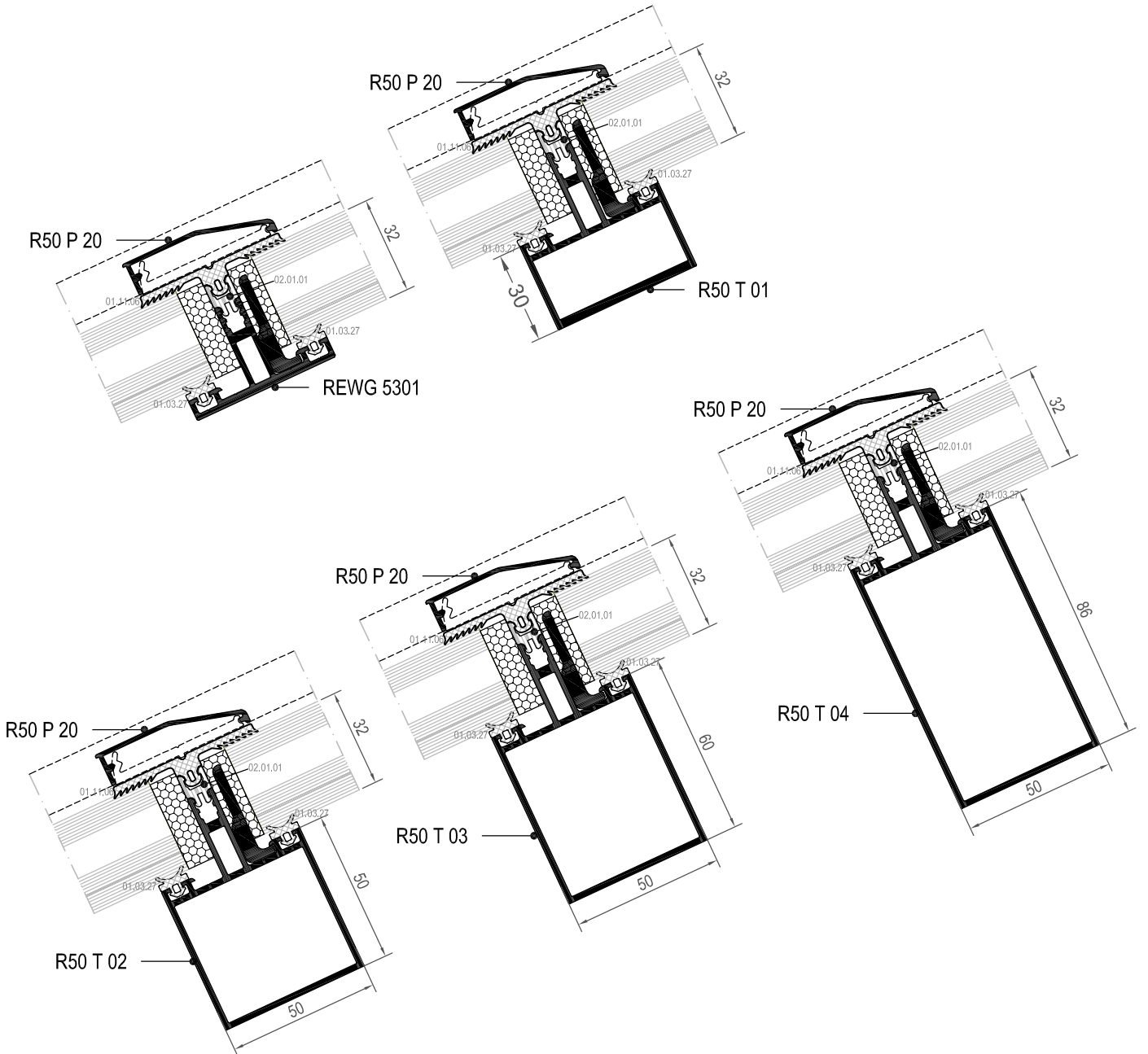
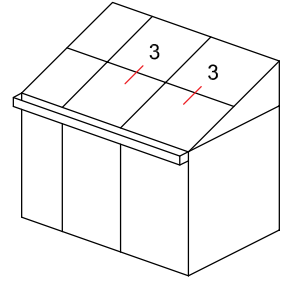

Ölçek / Scale : 1/2

③ DETAYI  
DETAIL

## AŞIK KRIŞ DETAYI RAFTER DETAIL

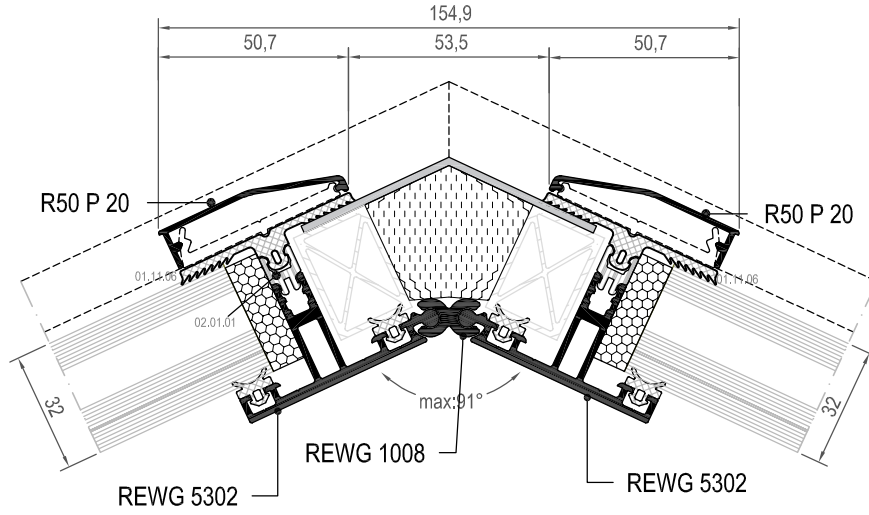
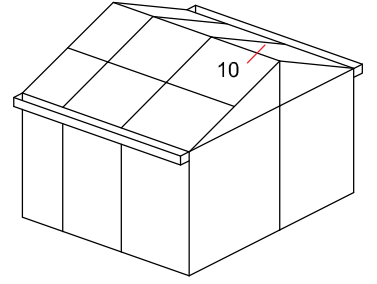

Ölçek / Scale : 1/2

10 DETAYI  
DETAIL

KRIŞ VE YAPISAL KRIŞ DETAYI  
RAFTER AND STRUCTUAL RAFTER DETAIL

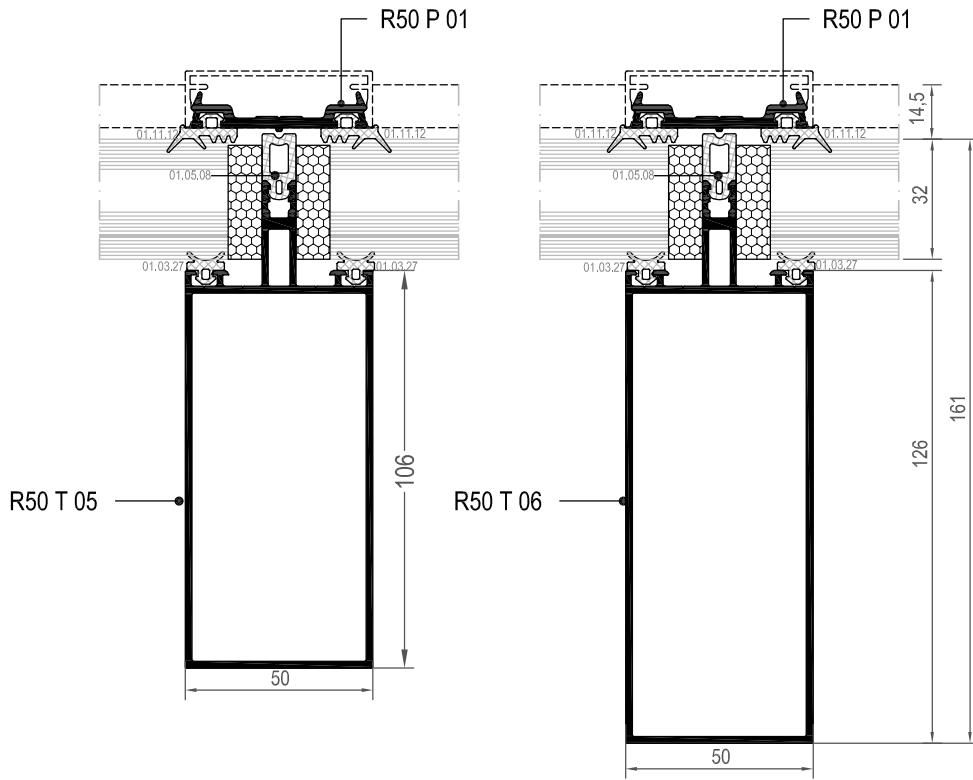
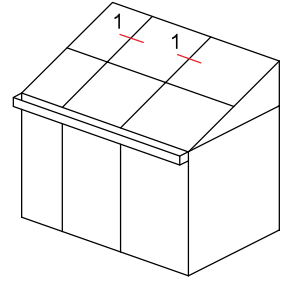

Ölçek / Scale : 1/2

① DETAYI  
DETAIL

KENAR KRİŞ DETAYI  
VERGE RAFTER DETAIL

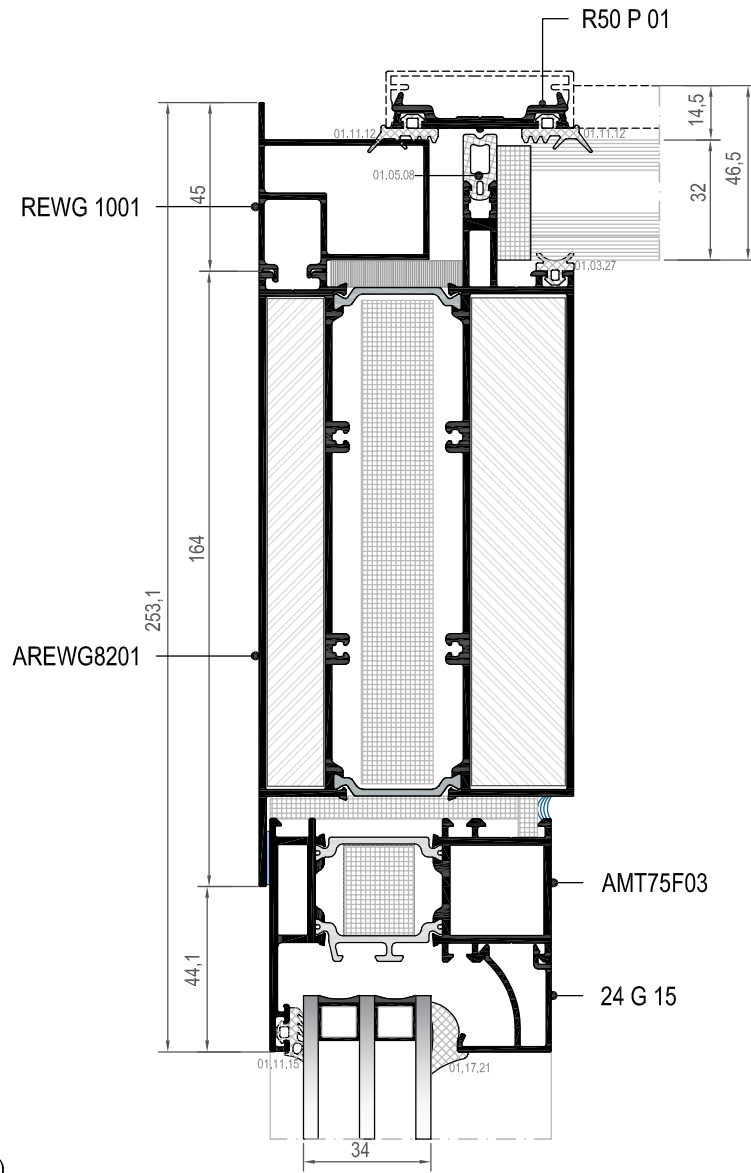
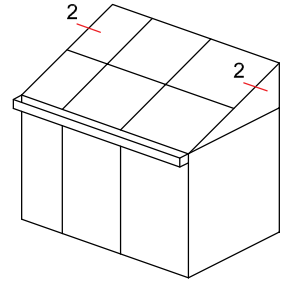

DIŞ  
(OUTSIDE)

Ölçek / Scale : 1/2

② DETAYI  
DETAIL

## 126MM SIRT KRİŞ DETAYI RIDGE WITH 126MM RAFTER DETAIL

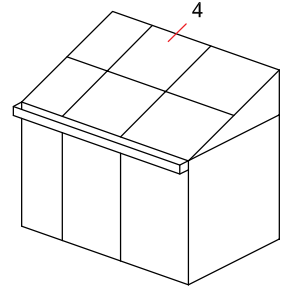

DIŞ  
(OUTSIDE)

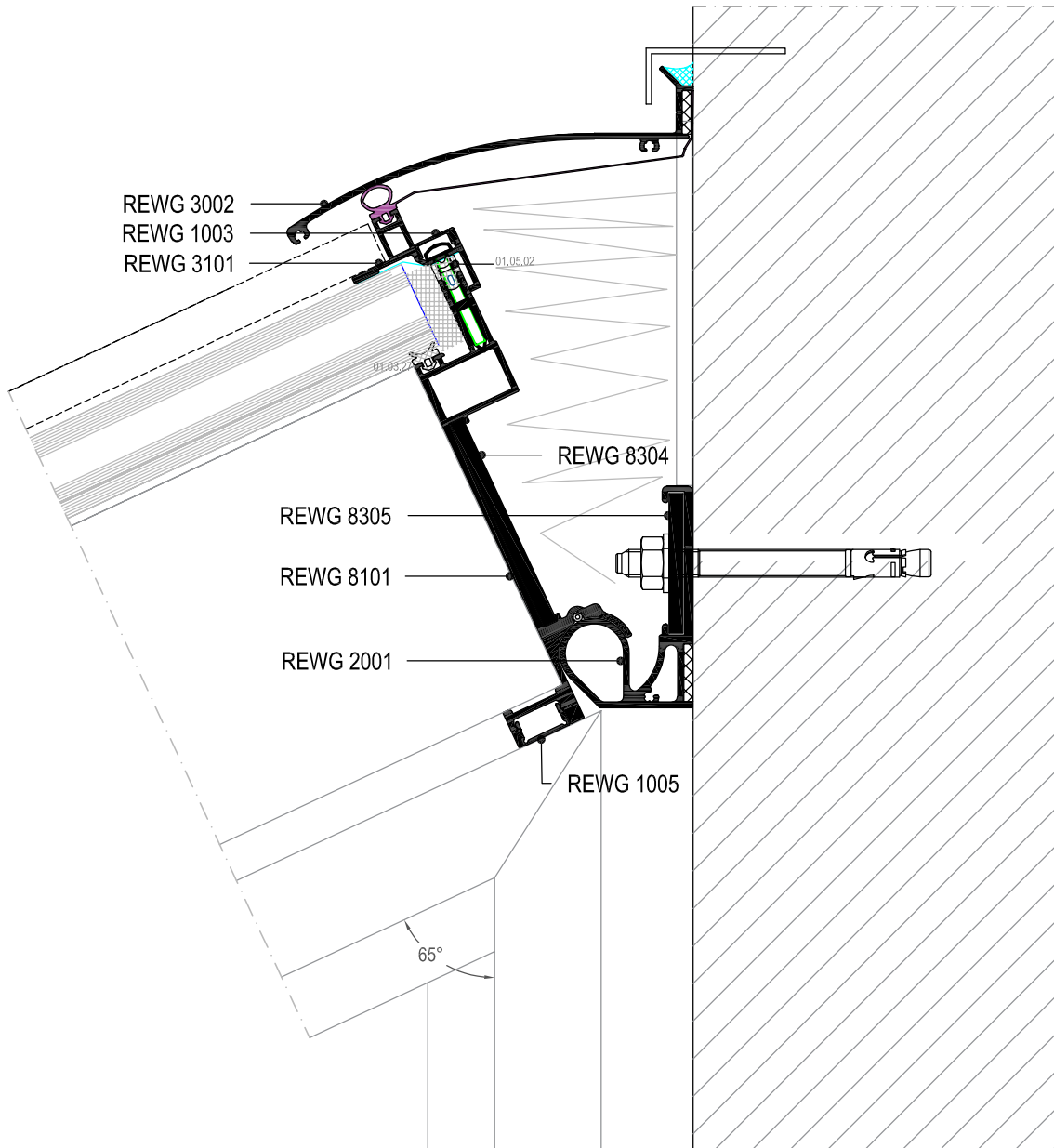

Ölçek / Scale : 1/2

4 DETAYI  
DETAIL

## DEĞİŞKEN AÇILI AŞIK KRİŞ DETAYI HIP RAFTER DETAIL

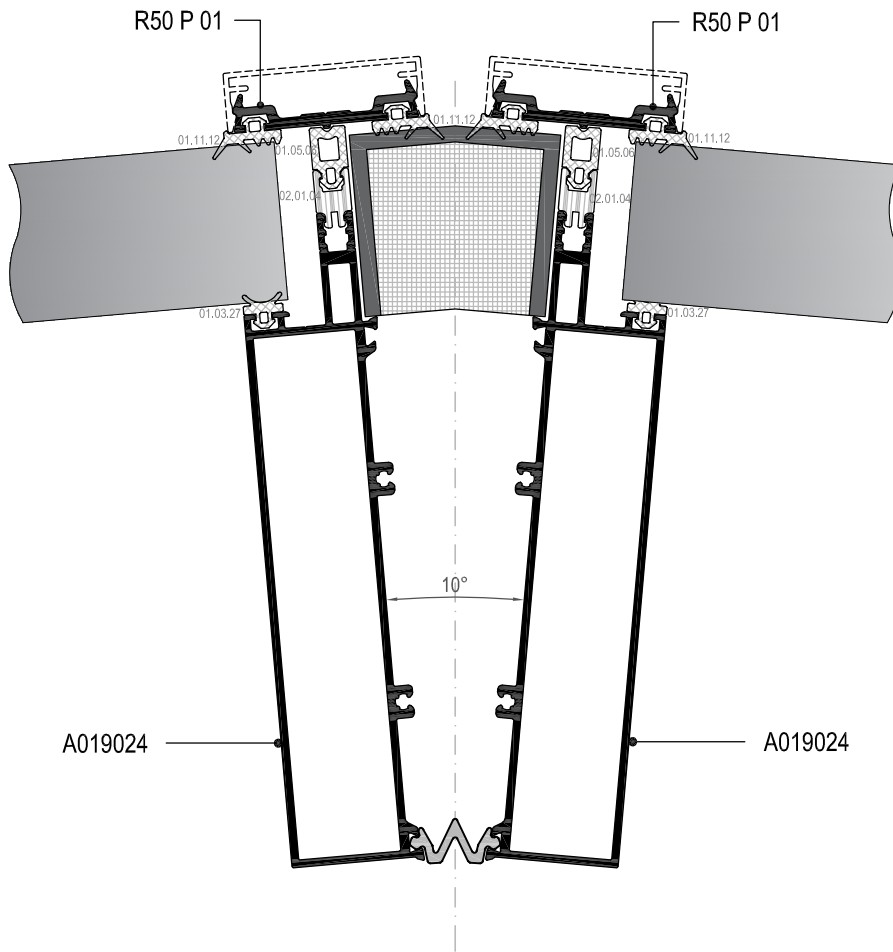
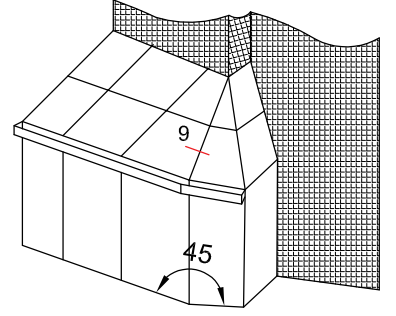

Ölçek / Scale : 1/2

9 DETAYI  
DETAIL

SAÇAK TAŞIYICI DETAYI İÇİN KÖŞE PROFİLİ 84 VE 121MM  
CORNER MULLION FOR EAVES DETAIL 84 AND 121MM

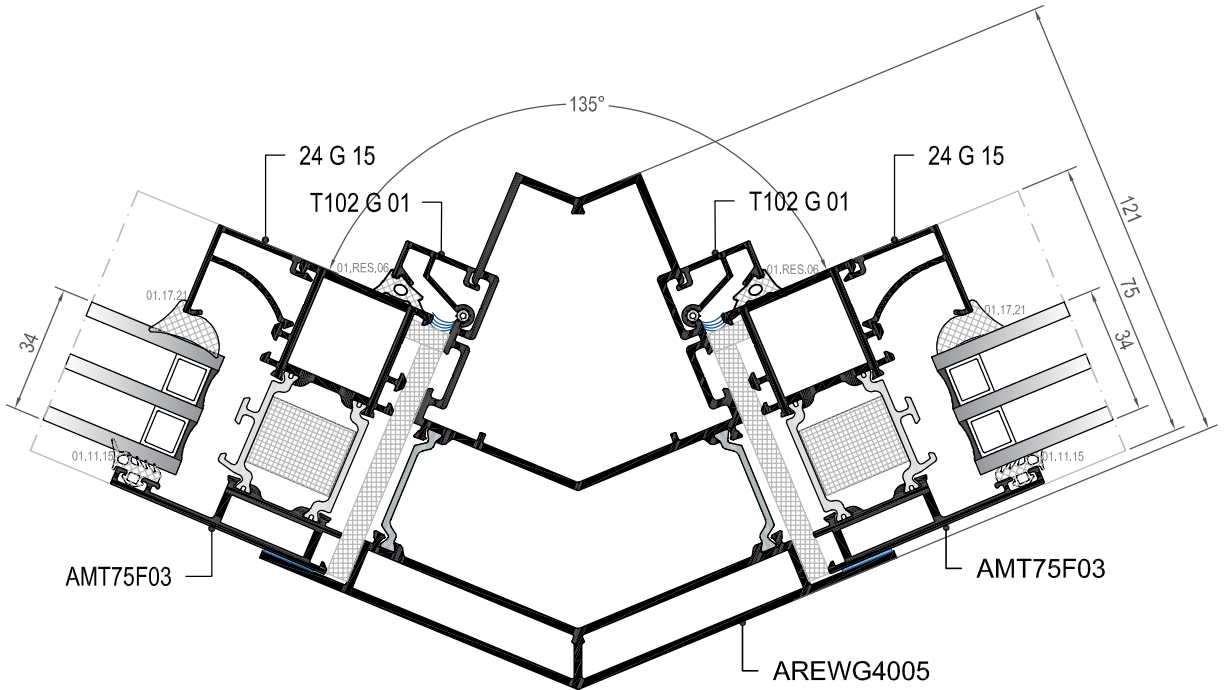
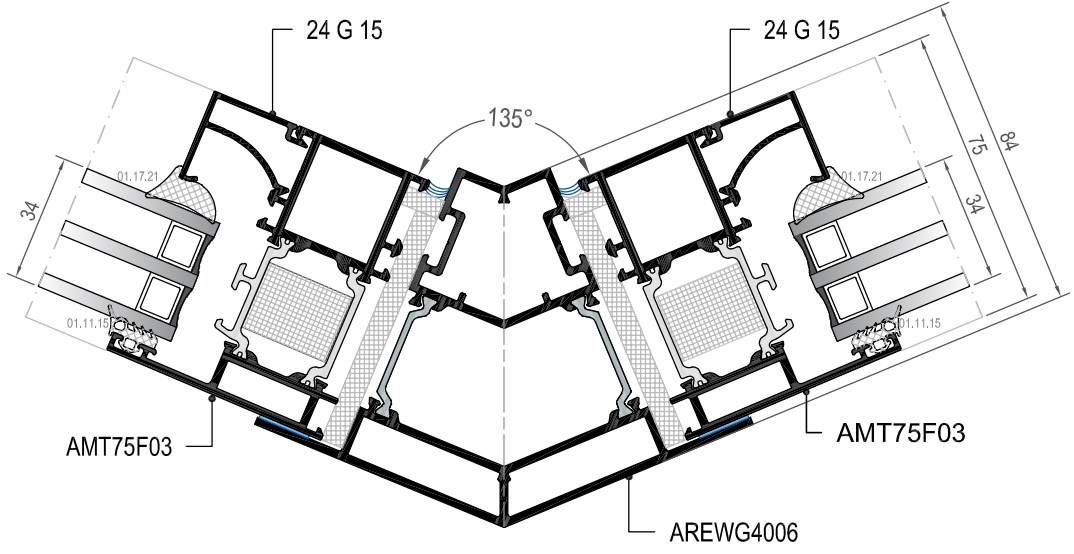
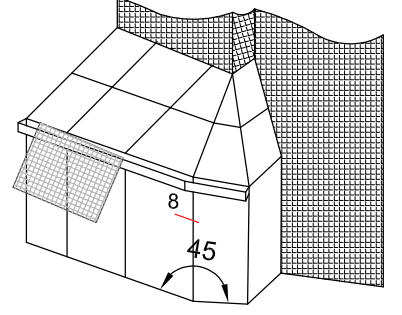

Ölçek / Scale : 1/2

8 DETAYI  
DETAIL

Tarih/Date: JANUARY 2022

DIŞ  
(OUTSIDE)

Page/Sayfa: D - 12

SAÇAK TAŞIYICI DETAYI İÇİN KÖŞE PROFİLİ 121MM  
CORNER MULLION FOR EAVES DETAIL 121MM

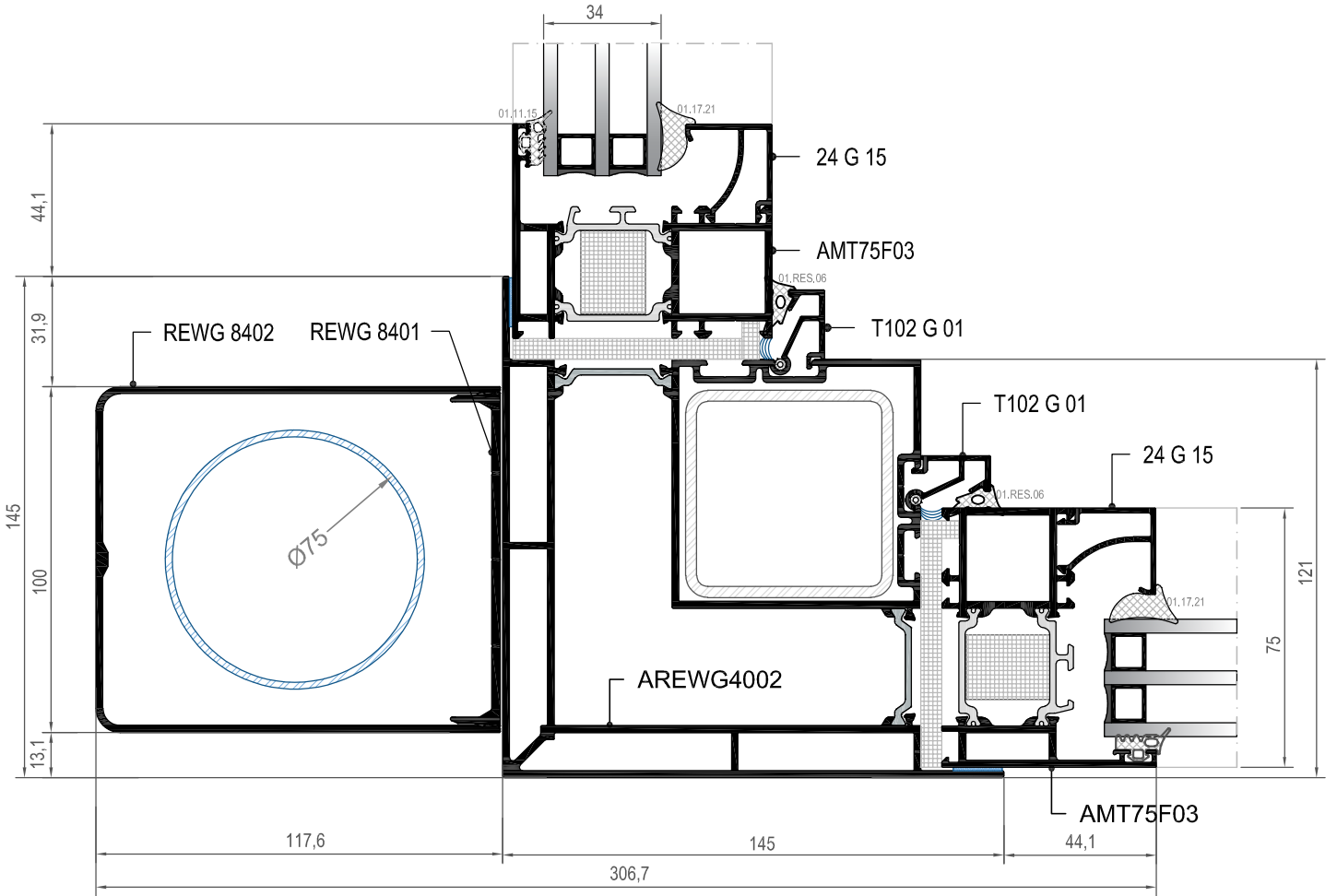
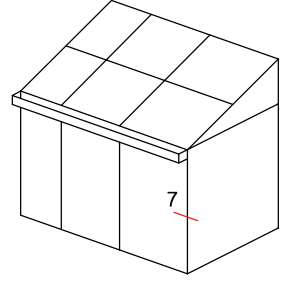

Ölçek / Scale : 1/2

7 DETAYI  
DETAIL

Tarih/Date: JANUARY 2022

DIŞ  
(OUTSIDE)

Page/Sayfa: D - 13



SAÇAK TAŞIYICI DETAYI İÇİN KÖŞE PROFİLİ 84 VE 121MM  
CORNER MULLION FOR EAVES DETAIL 84 AND 121MM

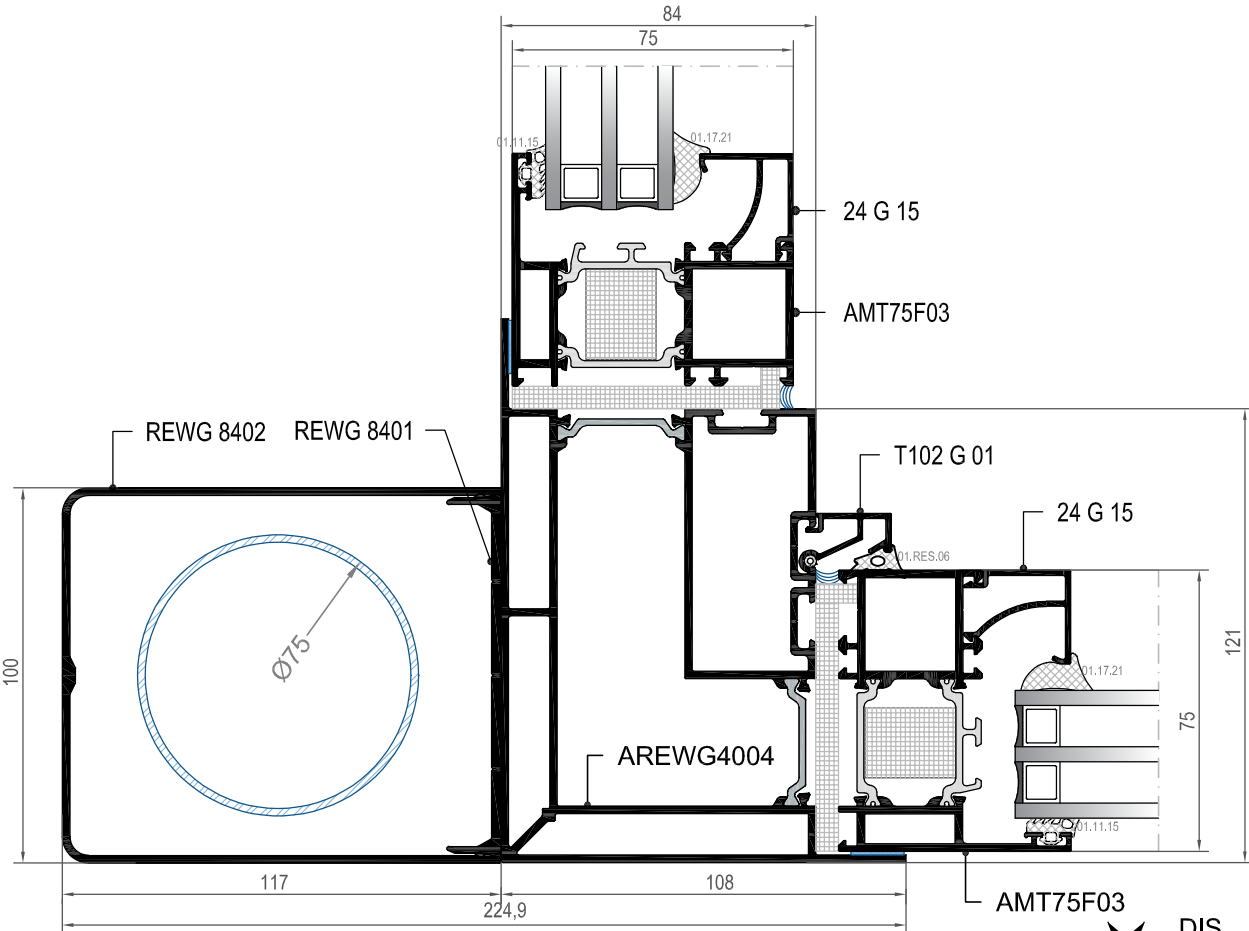
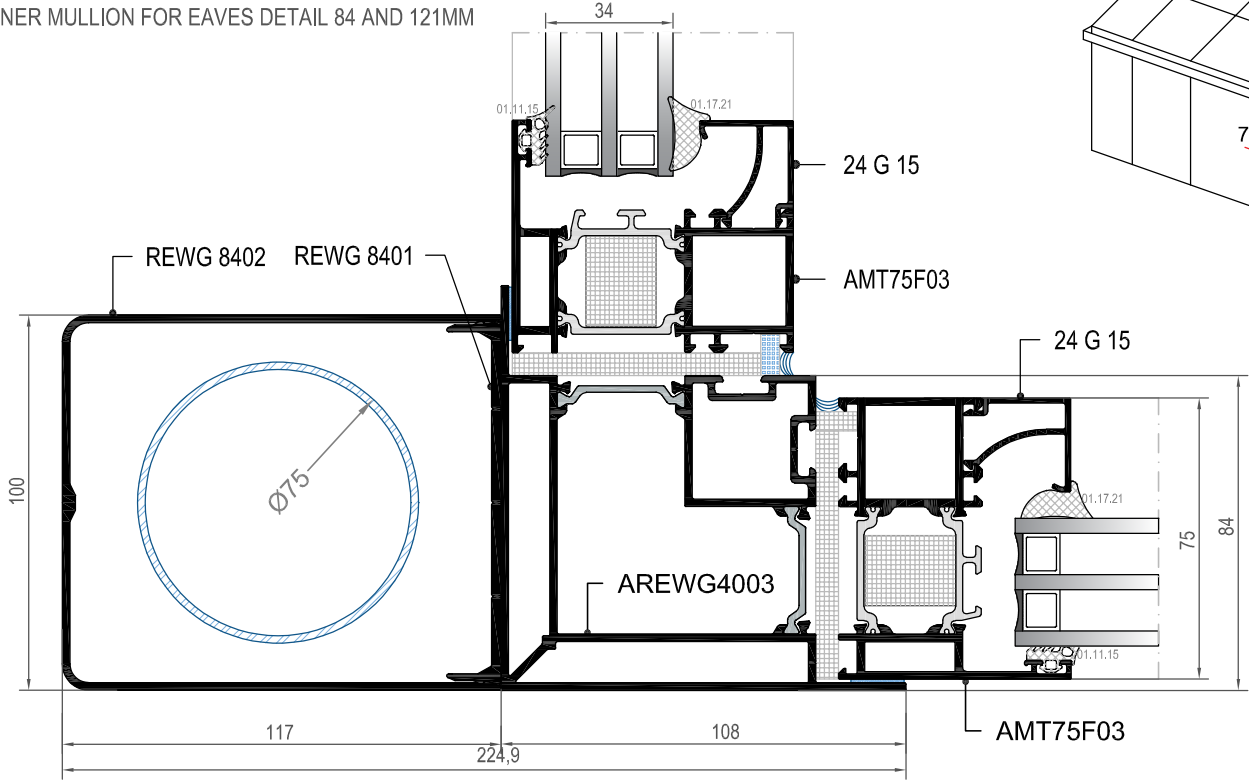
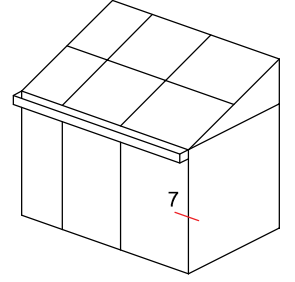

7 DETAYI  
DETAIL

Ölçek / Scale : 1/2

DIŞ  
(OUTSIDE)

SAÇAK TAŞIYICI DETAYI ASAŞ RWT75 SİSTEMİ İLE  
CENTRE MULLION WITH ASAŞ RWT75

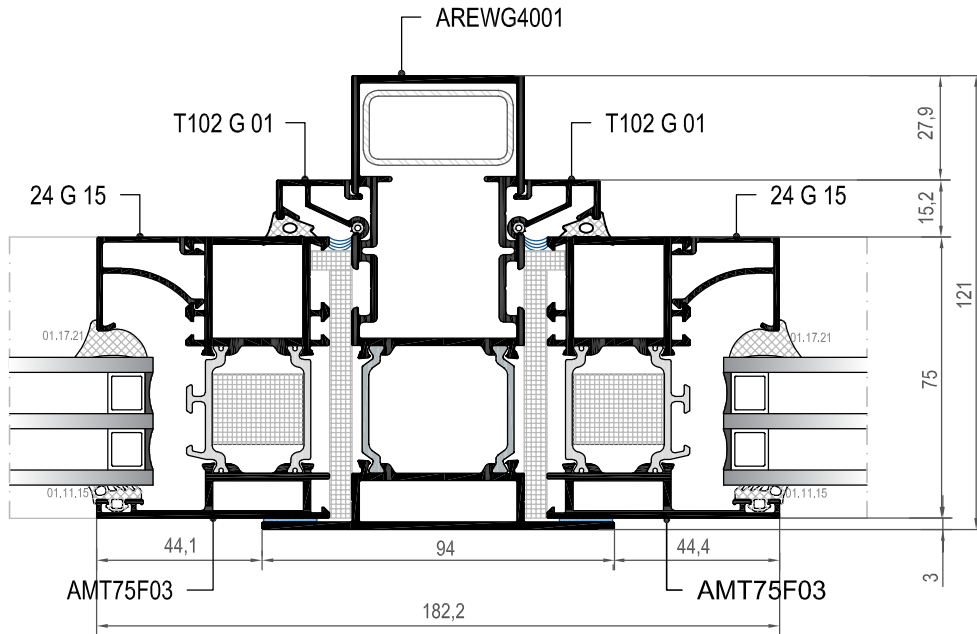
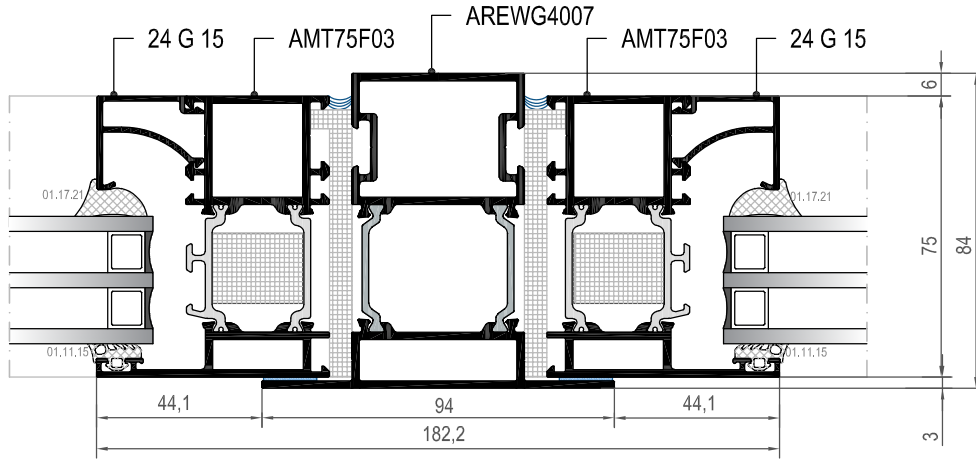
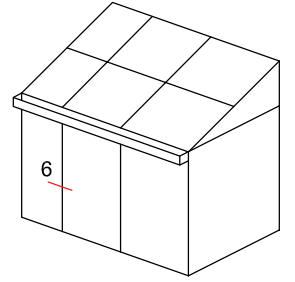

Ölçek / Scale : 1/2

⑥ DETAYI  
DETAIL

Tarih/Date: JANUARY 2022

DIŞ  
(OUTSIDE)

Page/Sayfa: D - 15

SAÇAK TAŞIYICI DETAYI ASAŞ RWT75 SİSTEMİ İLE  
CENTRE MULLION WITH ASAŞ RWT75

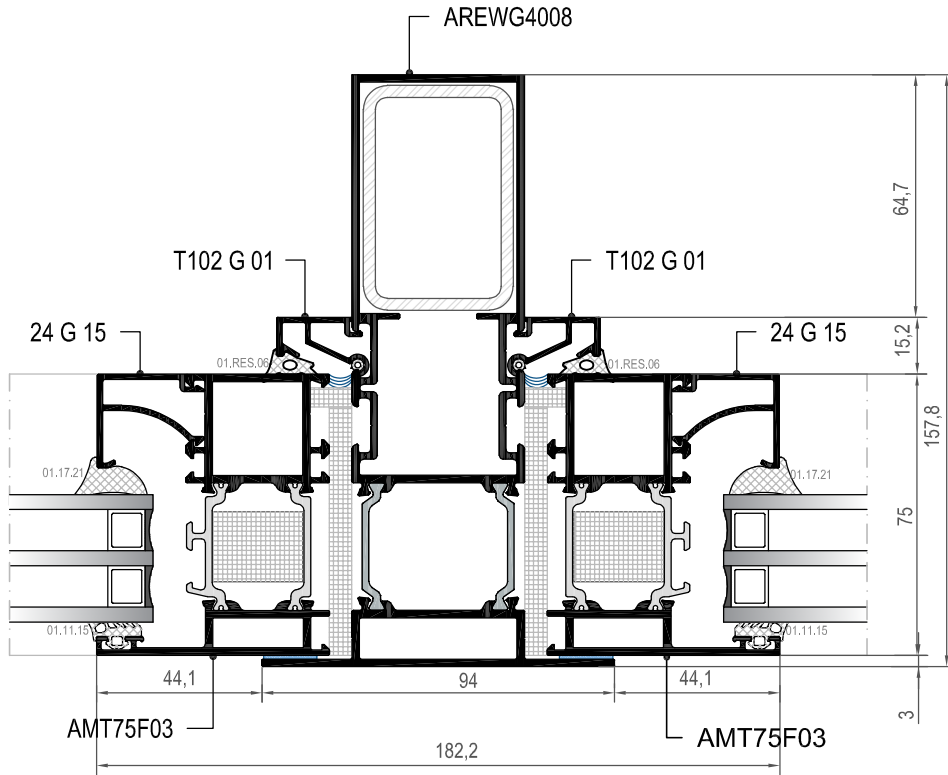
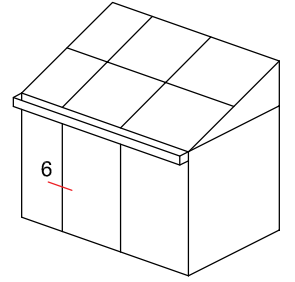

Ölçek / Scale : 1/2

⑥ DETAYI  
DETAIL

Tarih/Date: JANUARY 2022

DIŞ  
(OUTSIDE)

Page/Sayfa: D - 16

SAÇAK KRİŞ DETAYI ASAŞ RST116 SİSTEMİ İLE  
EAVES WITH ASAŞ RST116

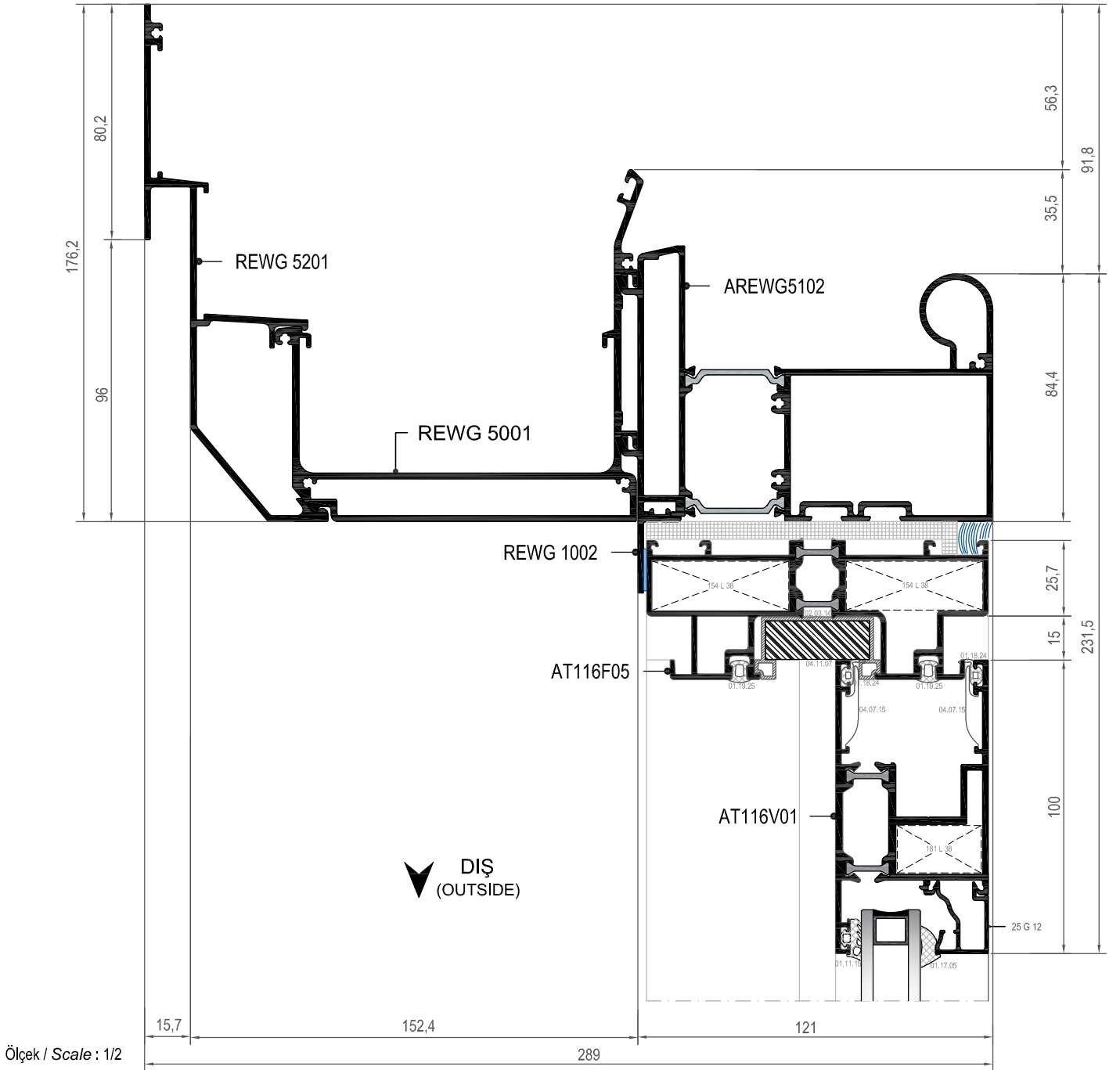
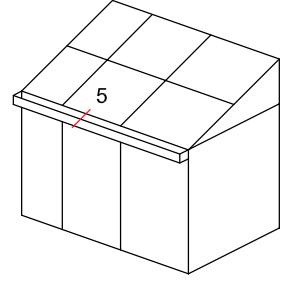

5 DETAYI  
DETAIL

SAÇAK TAŞIYICI DETAYI ASAŞ RST116 SİSTEMİ İLE  
CENTRE MULLION WITH ASAŞ RST116

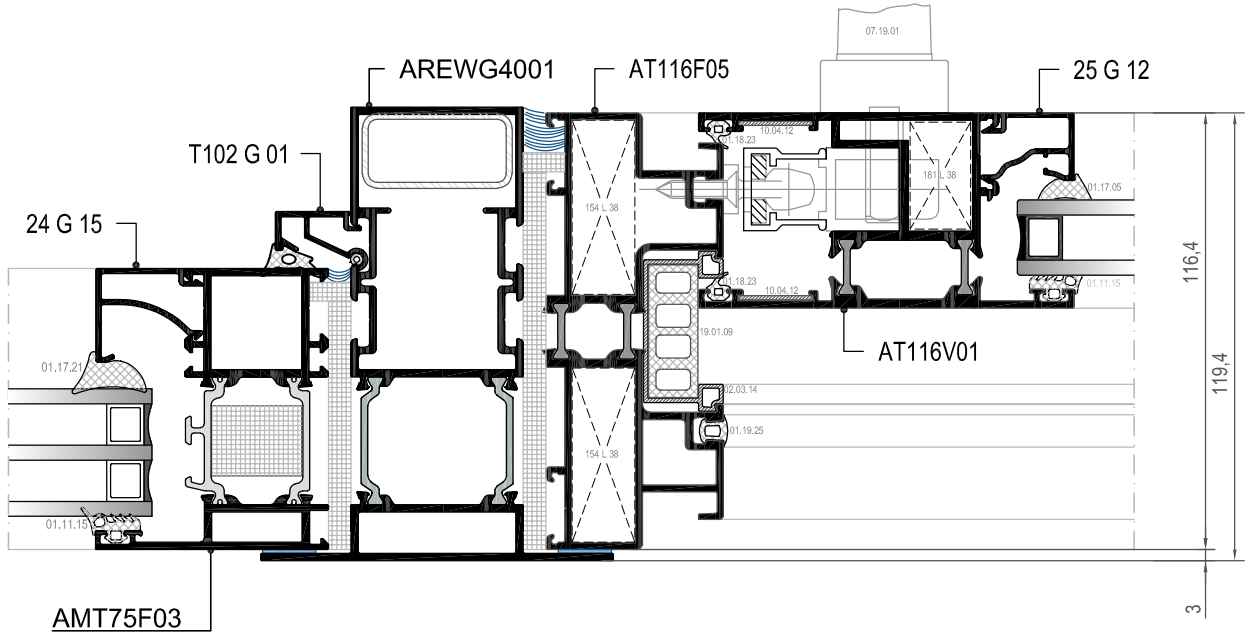
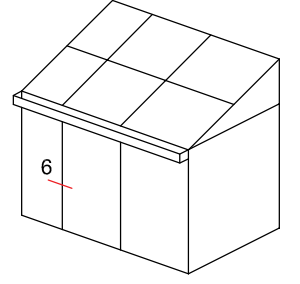

Ölçek / Scale : 1/2

5 DETAYI  
DETAIL

Tarih/Date: JANUARY 2022

DIŞ  
(OUTSIDE)

Page/Sayfa: D - 18

SAÇAK TAŞIYICI DETAYI İÇİN KÖŞE PROFİLİ RWT75 VE RST116 İLE  
CORNER MULLION FOR EAVES DETAIL WITH RWT75 AND RST116

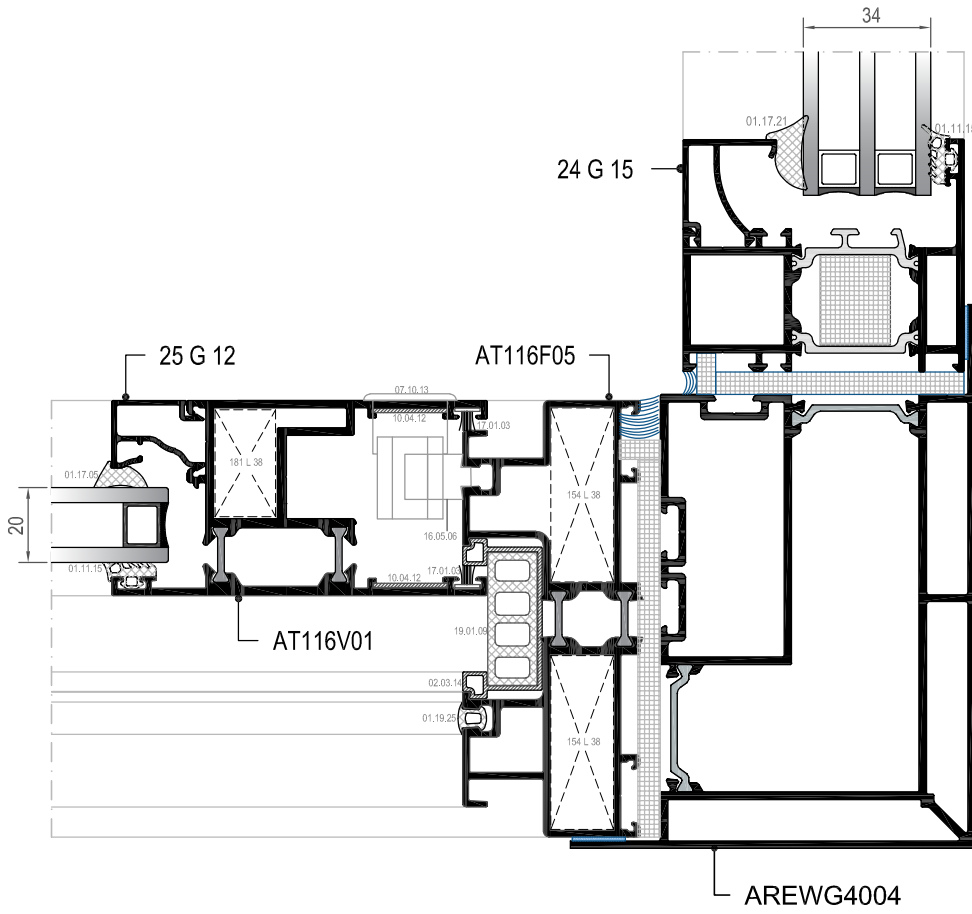
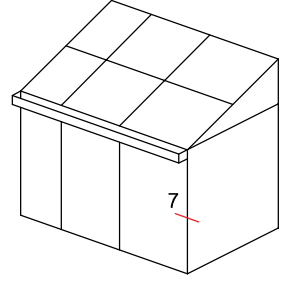

Ölçek / Scale : 1/2

7 DETAYI  
DETAIL

Tarih/Date: JANUARY 2022

DIŞ  
(OUTSIDE)

Page/Sayfa: D - 19

SAÇAK KRİŞ DETAYI ASAŞ RST58 SİSTEMİ İLE  
EAVES WITH ASAŞ RST58

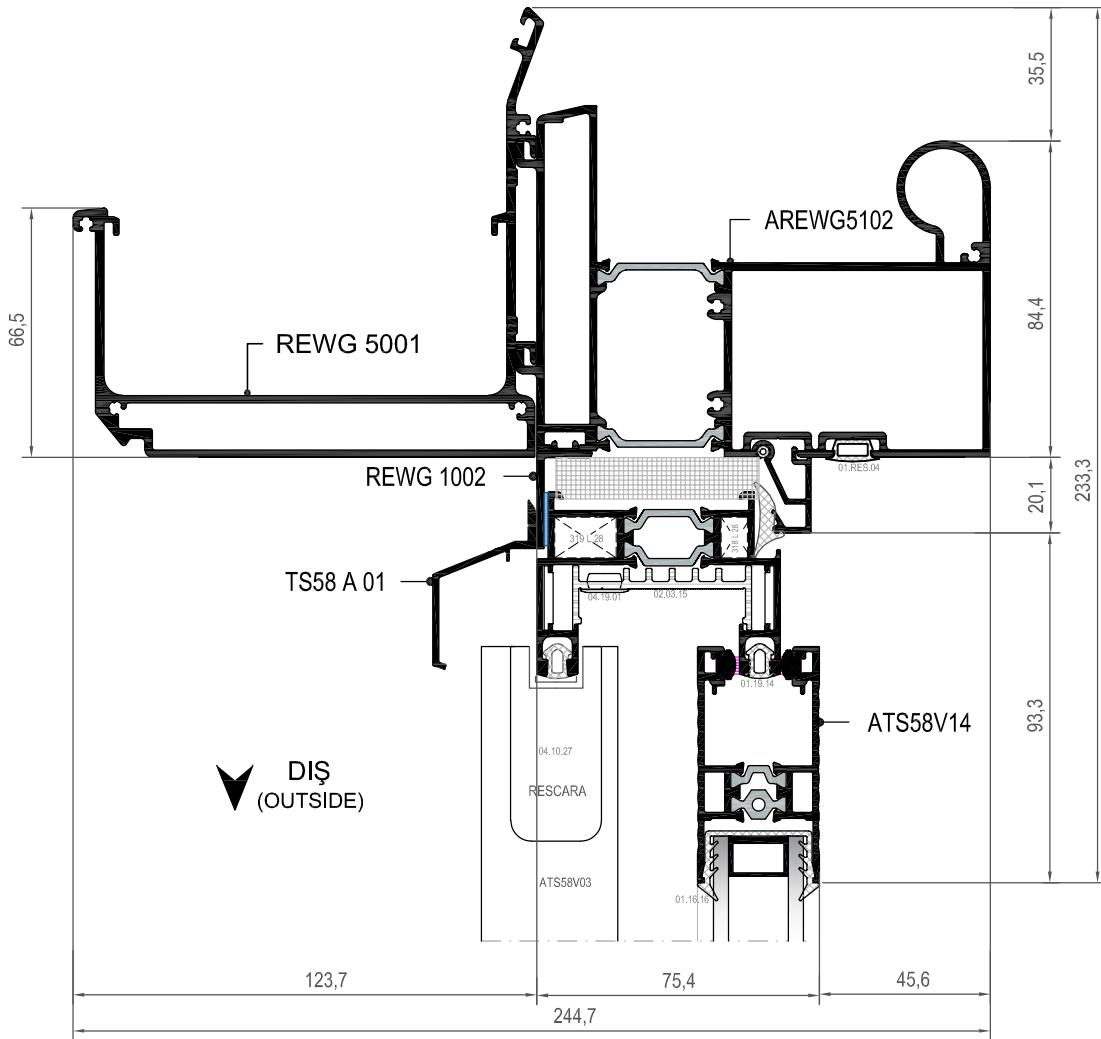
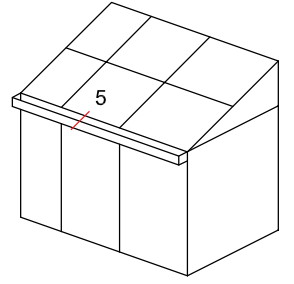

Ölçek / Scale : 1/2

5 DETAYI  
DETAIL

SAÇAK TAŞIYICI DETAYI ASAŞ RST58 VE RWT75 SİSTEMİ İLE  
CENTRE MULLION WITH ASAŞ RST58 AND RWT75

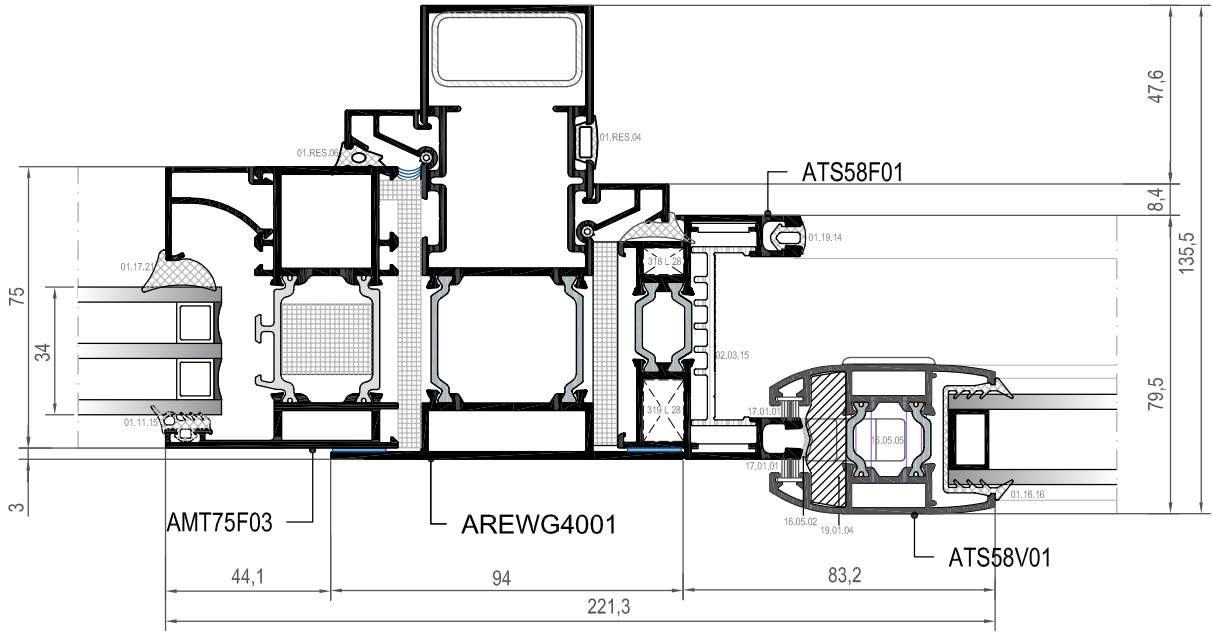
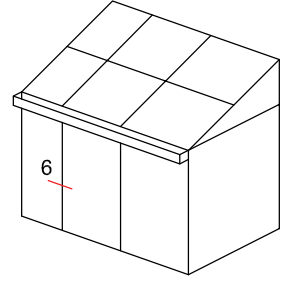

Ölçek / Scale : 1/2

⑥ DETAYI  
DETAIL

Tarih/Date: JANUARY 2022

DIŞ  
(OUTSIDE)

Page/Sayfa: D - 21





SAÇAK KRİŞ DETAYI ASAŞ RST102 SİSTEMİ İLE  
EAVES WITH ASAŞ RST102

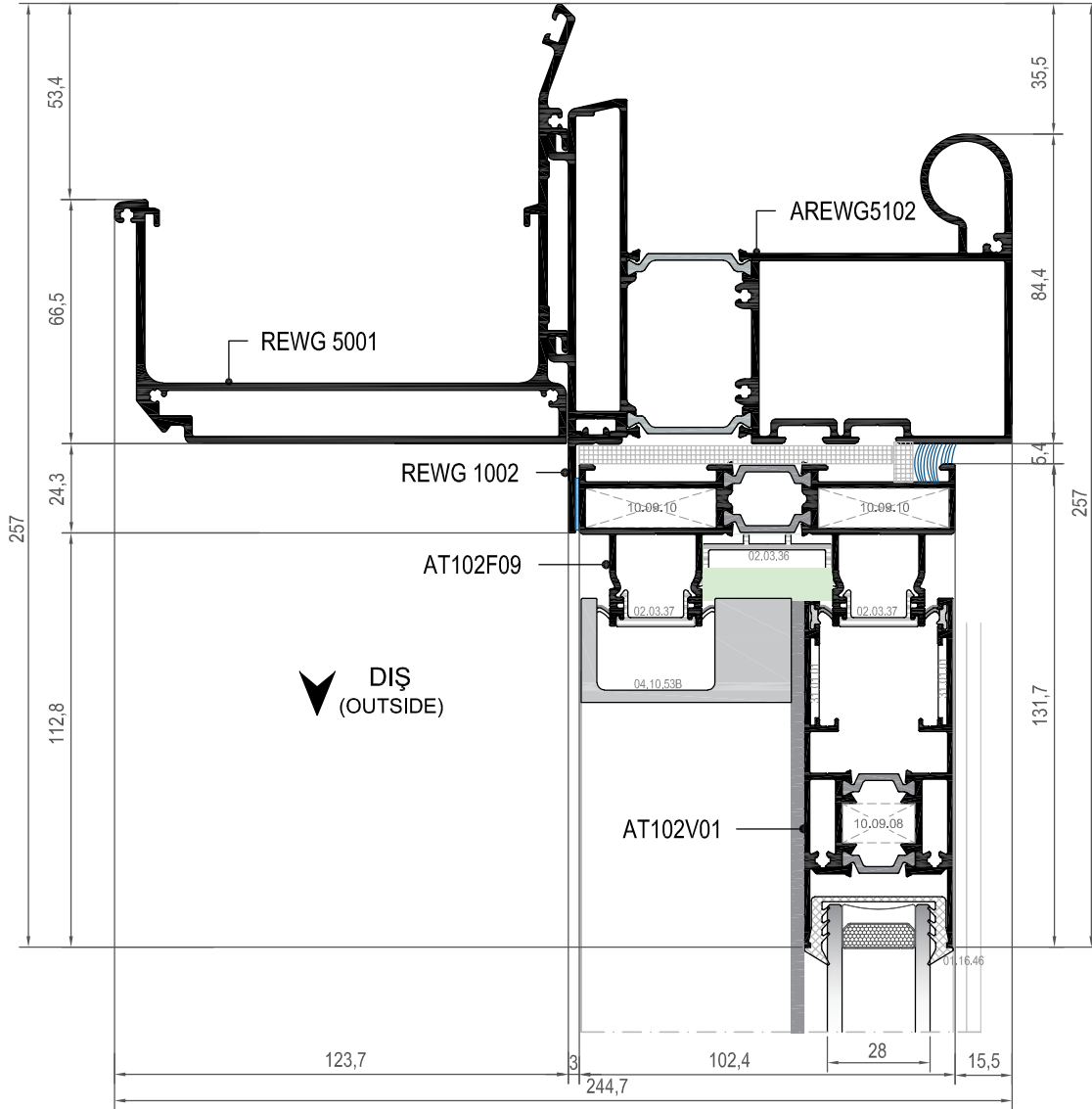
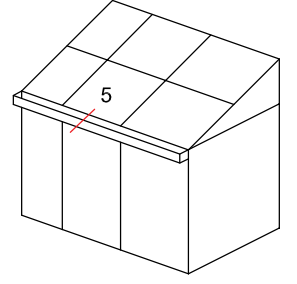

Ölçek / Scale : 1/2

5 DETAYI  
DETAIL

Tarih/Date: JANUARY 2022

Page/Sayfa: D - 23



SAÇAK TAŞIYICI DETAYI İÇİN KÖŞE PROFİLİ RWT75 VE RST102 İLE BİRLİKTE  
CORNER MULLION FOR EAVES DETAIL WITH RWT75 AND RST102

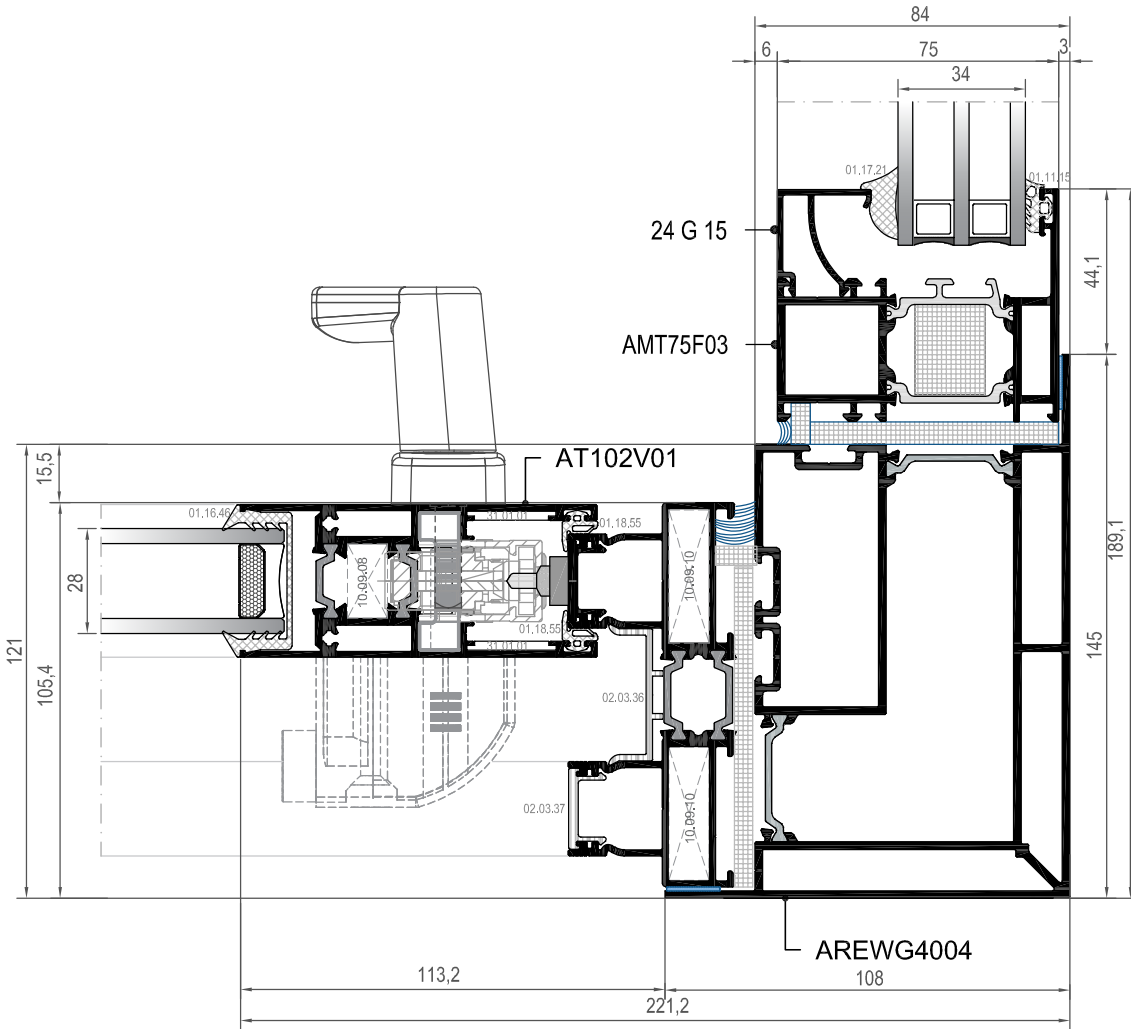
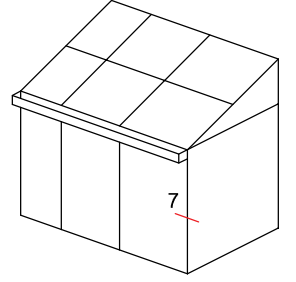

Ölçek / Scale : 1/2

7 DETAYI  
DETAIL

Tarih/Date: JANUARY 2022

DIŞ  
(OUTSIDE)

Page/Sayfa: D - 25

ASAŞ ÇATI PENCERESİ SKY65 YATAY TAŞIYICI ÜZERİNDEKİ DETAYI  
ASAŞ ROOF WINDOW SKY65 TRANSOM ATTACHMENT

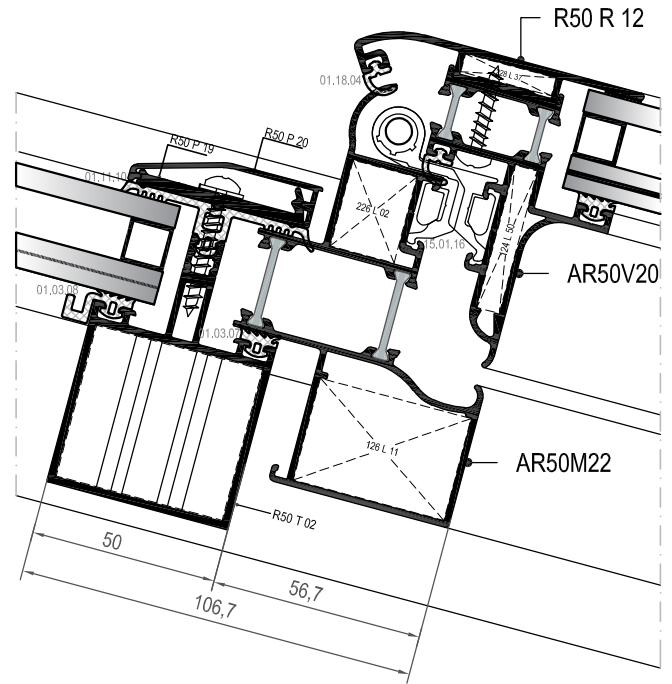
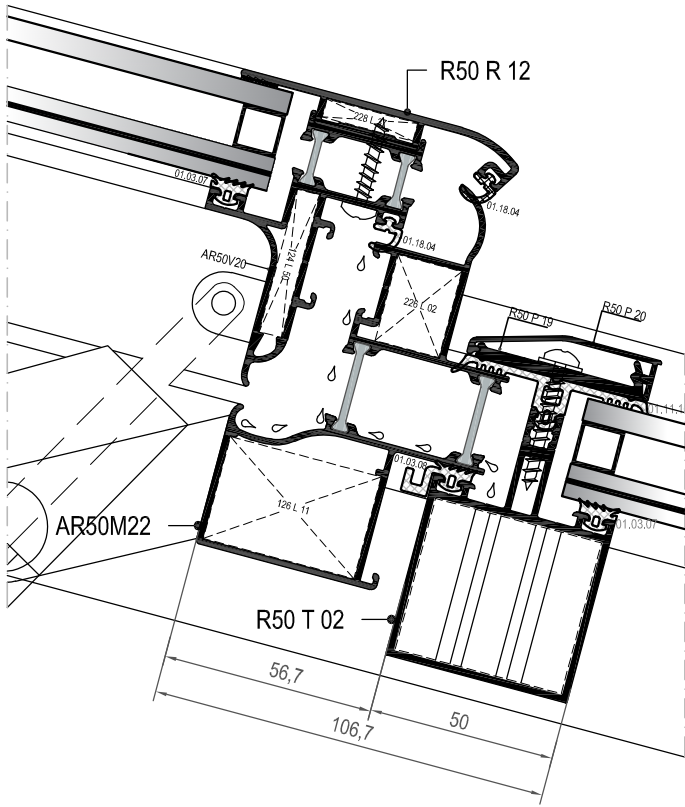
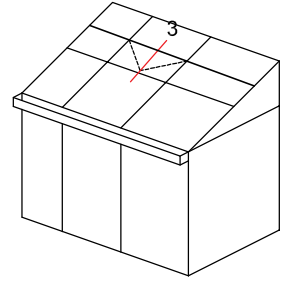

Ölçek / Scale : 1/2

③ DETAYI  
DETAIL

Tarih/Date: JANUARY 2022

Page/Sayfa: D - 26