

MİMARİ KATALOG

ARCHITECTURAL CATALOGUE

Alüminyum Kapı Pencere ve Giydirme Cephe Sistemleri
Aluminium Window Doors and Facade Systems

RSS

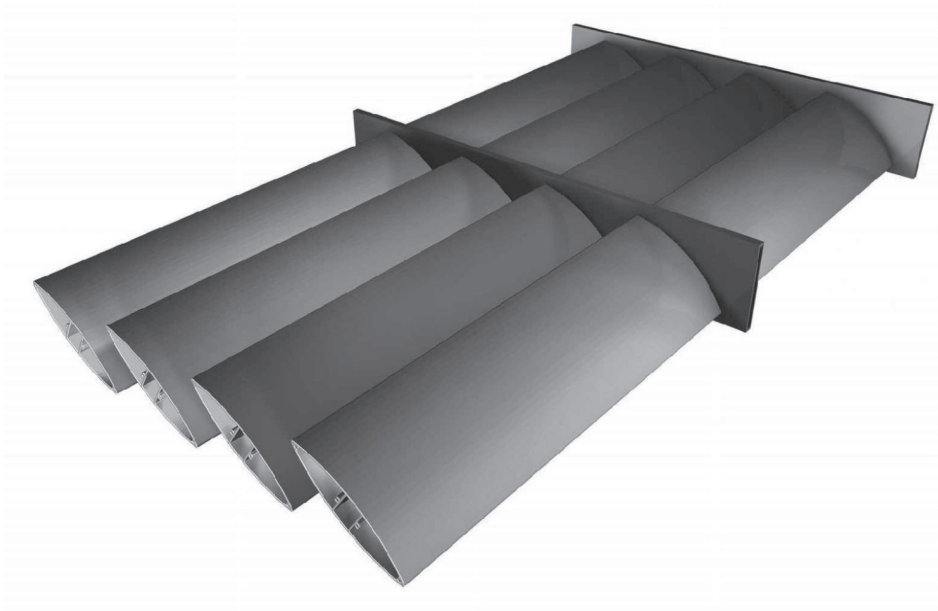

MİMARİ KATALOG

ARCHITECTURAL CATALOGUE

Alüminyum Kapı Pencere ve Giydirme Cephe Sistemleri
Aluminium Window Doors and Facade Systems

RSS

PROFİLLER

PROFILES

01

02

03

04

05

06

KOD / CODE	AĞIRLIK (kg/m) / WEIGHT	L m	KOD / CODE	AĞIRLIK (kg/m) / WEIGHT	L m
SOLAR P 03	0,944	6	SOLAR P 02	2,925	6
SOLAR P 17	1,057	6	SOLAR P 16	4,406	6
SOLAR P 19	1,529	6	SOLAR P 34	2,626	6



01

SOLAR P 03

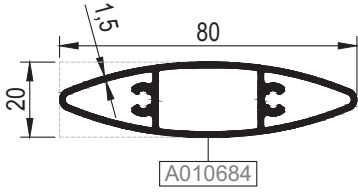

SOLAR P 17

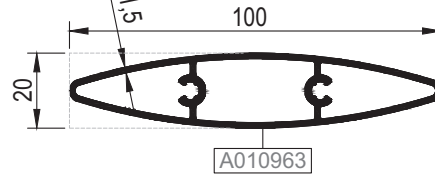

02

SOLAR P 19

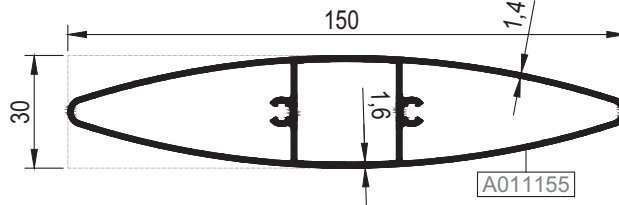

03

SOLAR P 34

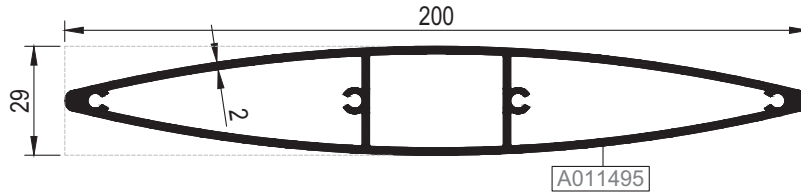

04

SOLAR P 02

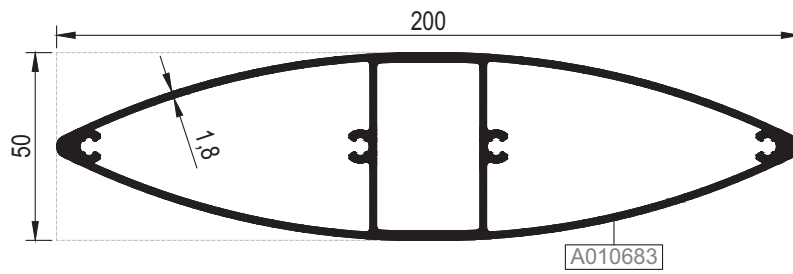

05

06

SOLAR P 16

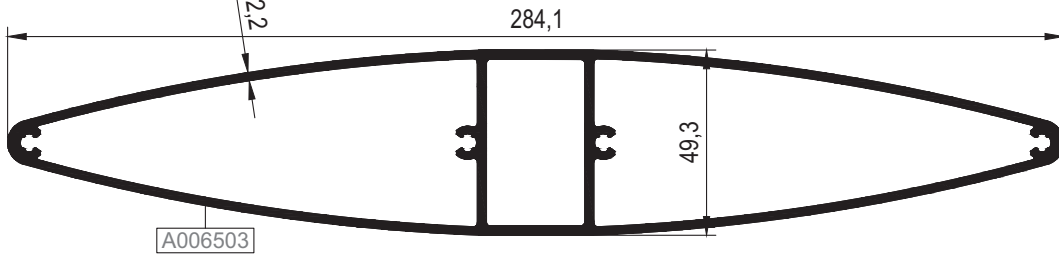

Ölçek/Scale: 1/2

KOD / CODE	AĞIRLIK (kg/m) / WEIGHT	L m	KOD / CODE	AĞIRLIK (kg/m) / WEIGHT	L m
SOLAR P 24	4,182	6	SOLAR P 27	6,677	6
1148	0,980	6	SOLAR P 32	3,905	6
1147	1,817	6			

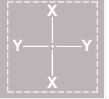

SOLAR P 24

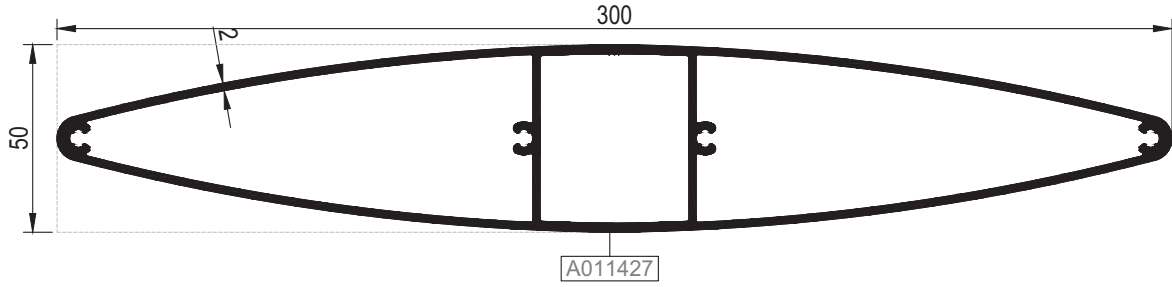

SOLAR P 32

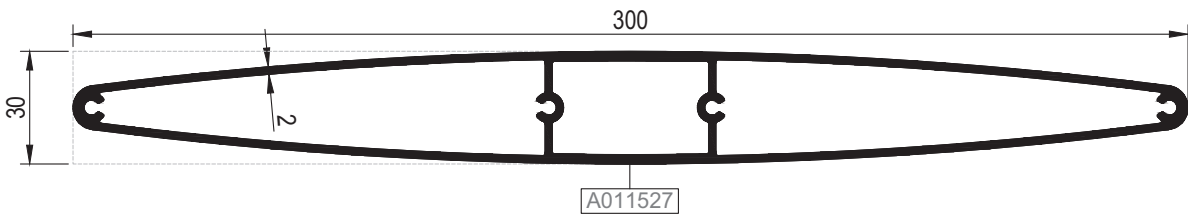

SOLAR P 27

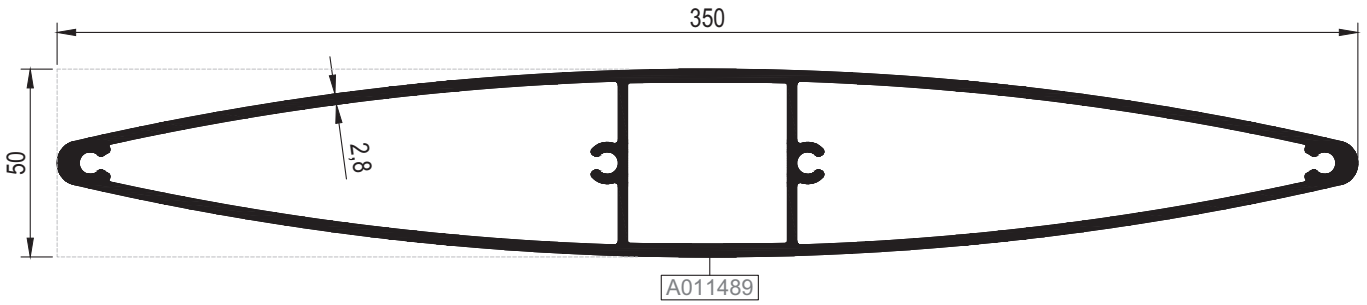

A001148

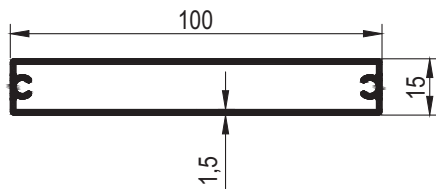

A001147

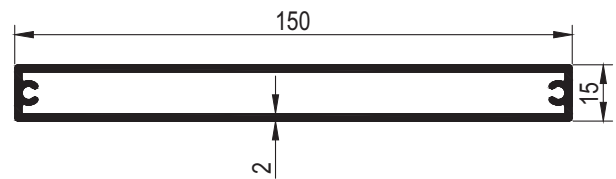

Ölçek/Scale: 1/2

KOD / CODE	AĞIRLIK (kg/m) / WEIGHT	L m	KOD / CODE	AĞIRLIK (kg/m) / WEIGHT	L m
SOLAR P 20	9,677	6			
SOLAR P 21	7,033	6			



01

02

03

04

05

06

SOLAR P 20

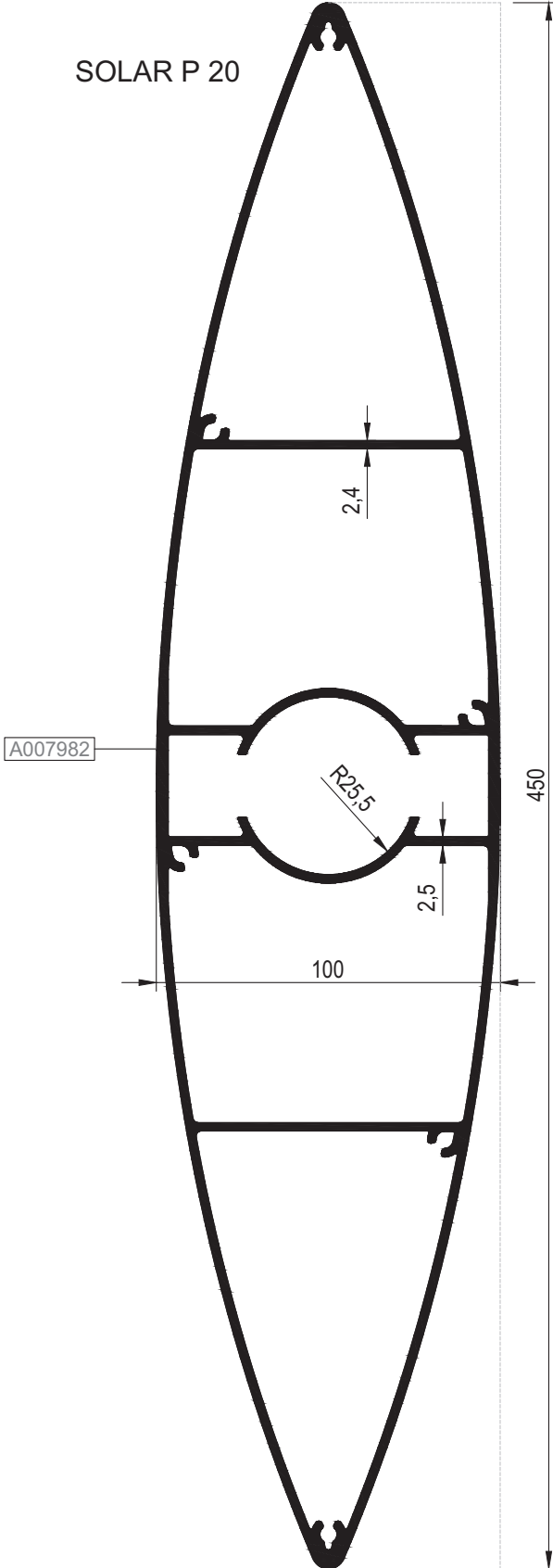

SOLAR P 21

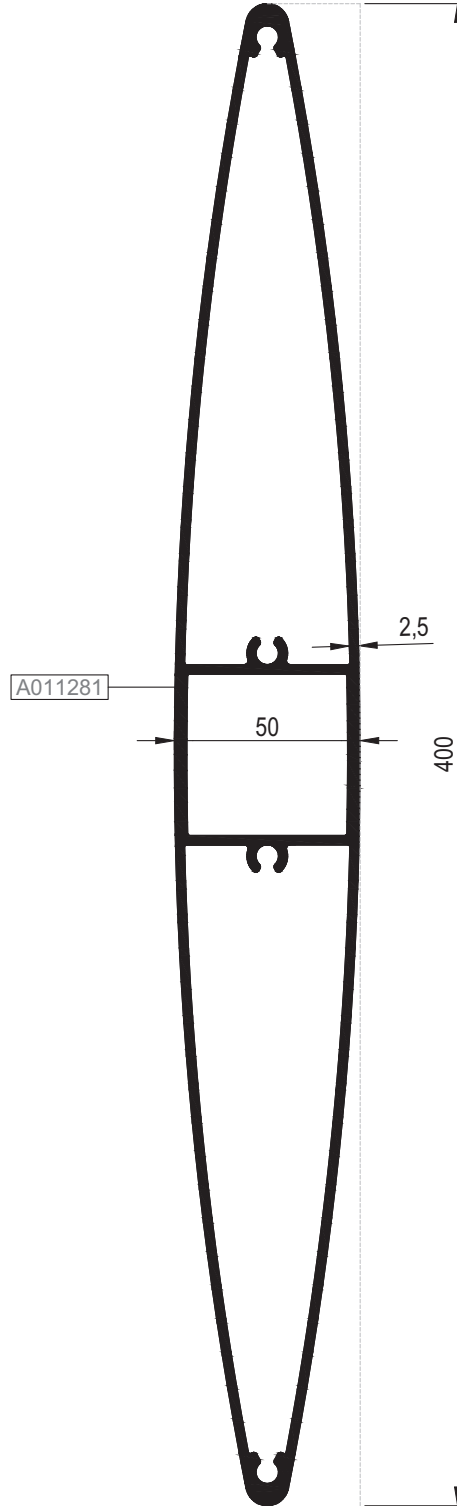

Ölçek/Scale: 1/2

KOD / CODE	AĞIRLIK (kg/m) / WEIGHT	L m	KOD / CODE	AĞIRLIK (kg/m) / WEIGHT	L m
SOLAR P 22	2,305	6	SOLAR P 13	1,785	6
SOLAR P 26	1,679	6	SOLAR P 14	1,570	6

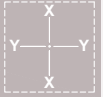

SOLAR P 22

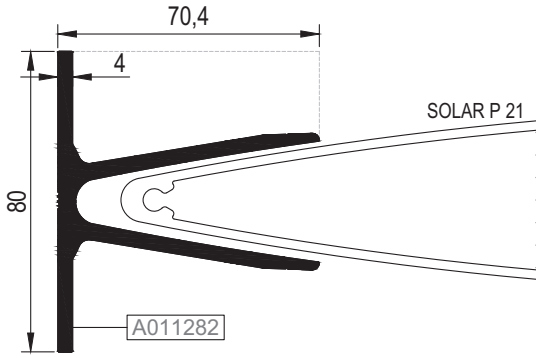

SOLAR P 21 İÇİN / FOR SOLAR P 21

SOLAR P 26

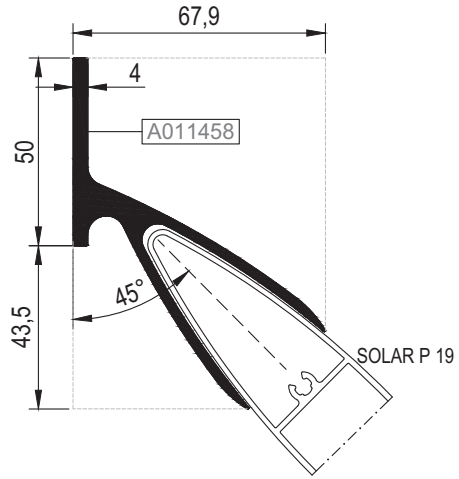

SOLAR P 19 İÇİN / FOR SOLAR P 19

SOLAR P 13

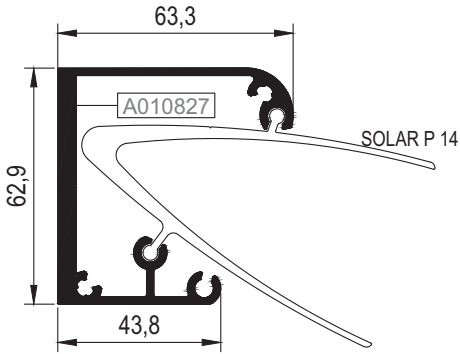

SOLAR P 14 İÇİN / FOR SOLAR P 14

SOLAR P 14

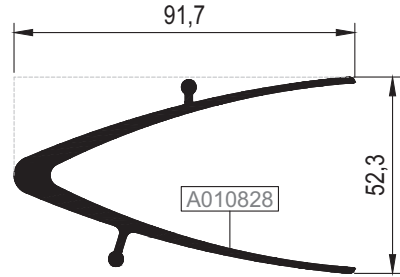

SOLAR P 02 İÇİN / FOR SOLAR P 02

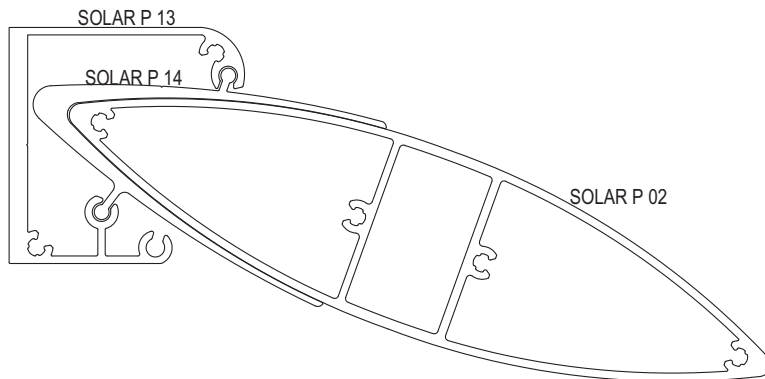

Ölçek/Scale: 1/2

KOD / CODE	AĞIRLIK (kg/m) / WEIGHT	L m	KOD / CODE	AĞIRLIK (kg/m) / WEIGHT	L m
SOLAR P 28	1,582	6	SOLAR P 31	2,411	6
SOLAR P 29	2,385	6	SOLAR P 33	1,672	6
SOLAR P 30	2,192	6	SOLAR P 41	2,320	6



01

SOLAR P 28

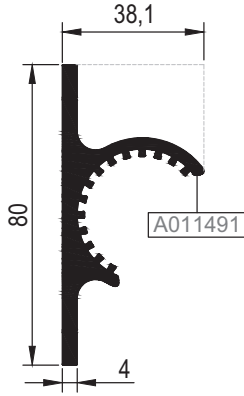

02

SOLAR P 29

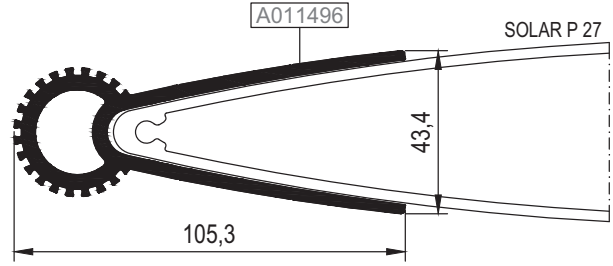

SOLAR P 27 İÇİN / FOR SOLAR P 27

03

SOLAR P 30

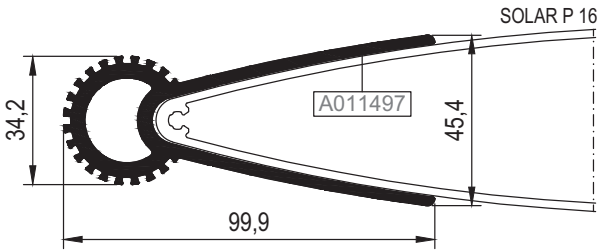

SOLAR P 16 İÇİN / FOR SOLAR P 16

04

SOLAR P 31

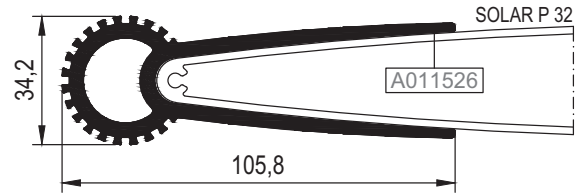

SOLAR P 32 İÇİN / FOR SOLAR P 32

05

SOLAR P 33

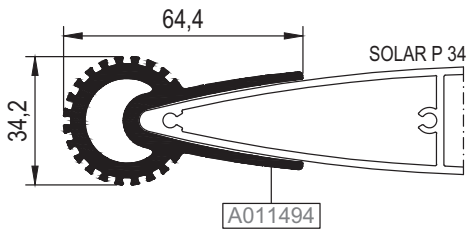

SOLAR P 34 İÇİN / FOR SOLAR P 34

06

SOLAR P 41

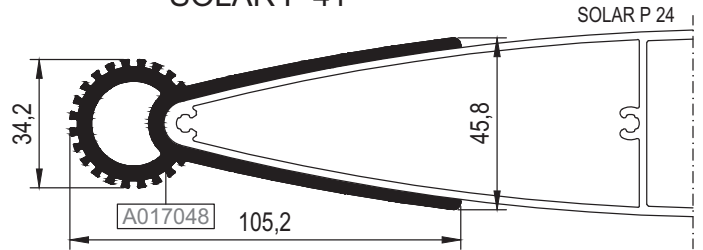

SOLAR P 24 İÇİN / FOR SOLAR P 24

Ölçek/Scale: 1/2

KOD / CODE	AĞIRLIK (kg/m) / WEIGHT	L m	KOD / CODE	AĞIRLIK (kg/m) / WEIGHT	L m
SOLAR P 35	0,541	6	SOLAR P 38	2,757	6
SOLAR P 36	0,967	6	SOLAR P 39	0,193	6
SOLAR P 37	1,466	6			

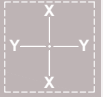

SOLAR P 35

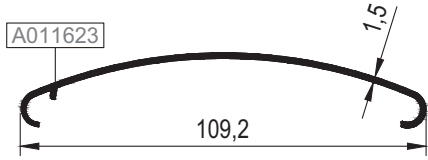

SOLAR P 38 İÇİN / FOR SOLAR P 38

SOLAR P 36

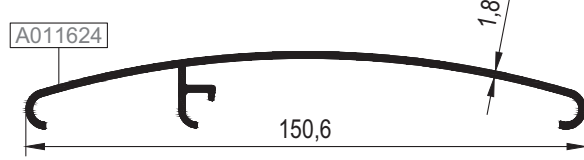

SOLAR P 38 İÇİN / FOR SOLAR P 38

SOLAR P 37

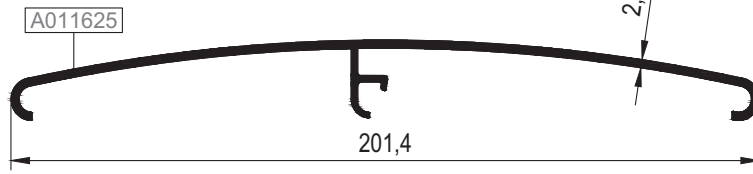

SOLAR P 38 İÇİN / FOR SOLAR P 38

SOLAR P 38

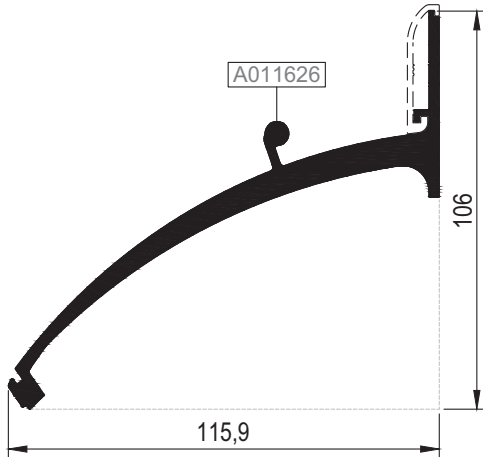

SOLAR P 39

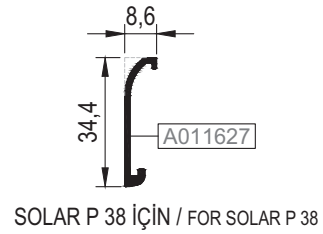

SOLAR P 38 İÇİN / FOR SOLAR P 38

Ölçek/Scale: 1/2

STOKTA BULUNAN SİSTEM PROFİLLERİNİN LİSTESİ (LIST OF SYSTEM PROFILES IN STOCK)

Nr	MIN. SİPARİŞ MİKTARI MIN. ORDER QUANTITY
SOLAR P 17 A010963	75 kg

* STOKTA BULUNMAYAN TÜM PROFİLLER İÇİN MİNİMUM SİPARİŞ MİKTARI 300 KG'DİR.
MINIMUM ORDER QUANTITY FOR ALL THE PROFILES THAT ARE NOT IN STOCK IS 300 KG.

MİMARİ KATALOG ARCHITECTURAL CATALOGUE

Alüminyum Kapı Pencere ve Giydirme Cephe Sistemleri
Aluminium Window Doors and Facade Systems

RSS

DETAYLAR

DETAILS

01

02

03

04

05

06

SOLAR P 02, SOLAR P 13, SOLAR P 14 İLE DETAY
DETAIL WITH SOLAR P 02 ,SOLAR P 13, SOLAR P 14

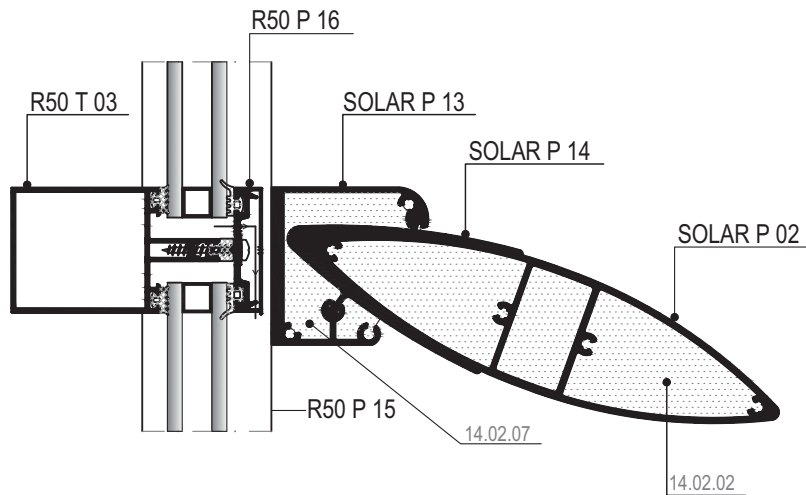
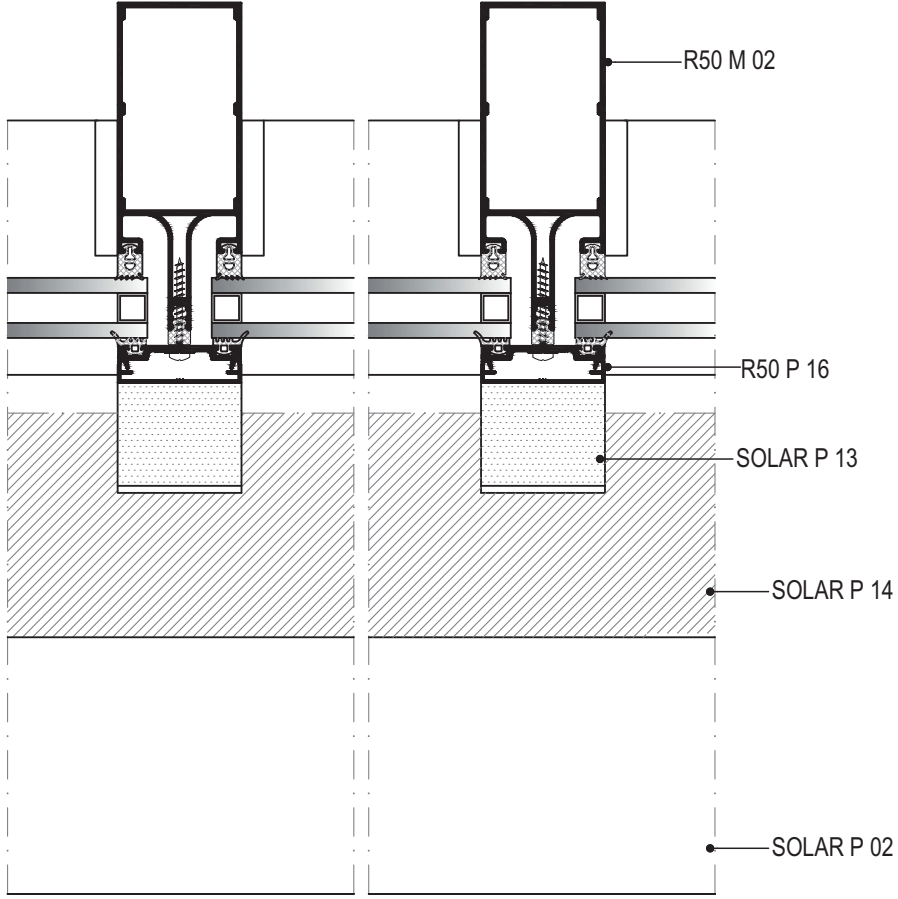

SOLAR P 28, SOLAR P 31, SOLAR P 32 İLE DETAY
DETAIL WITH SOLAR P 28 ,SOLAR P 31, SOLAR P 32

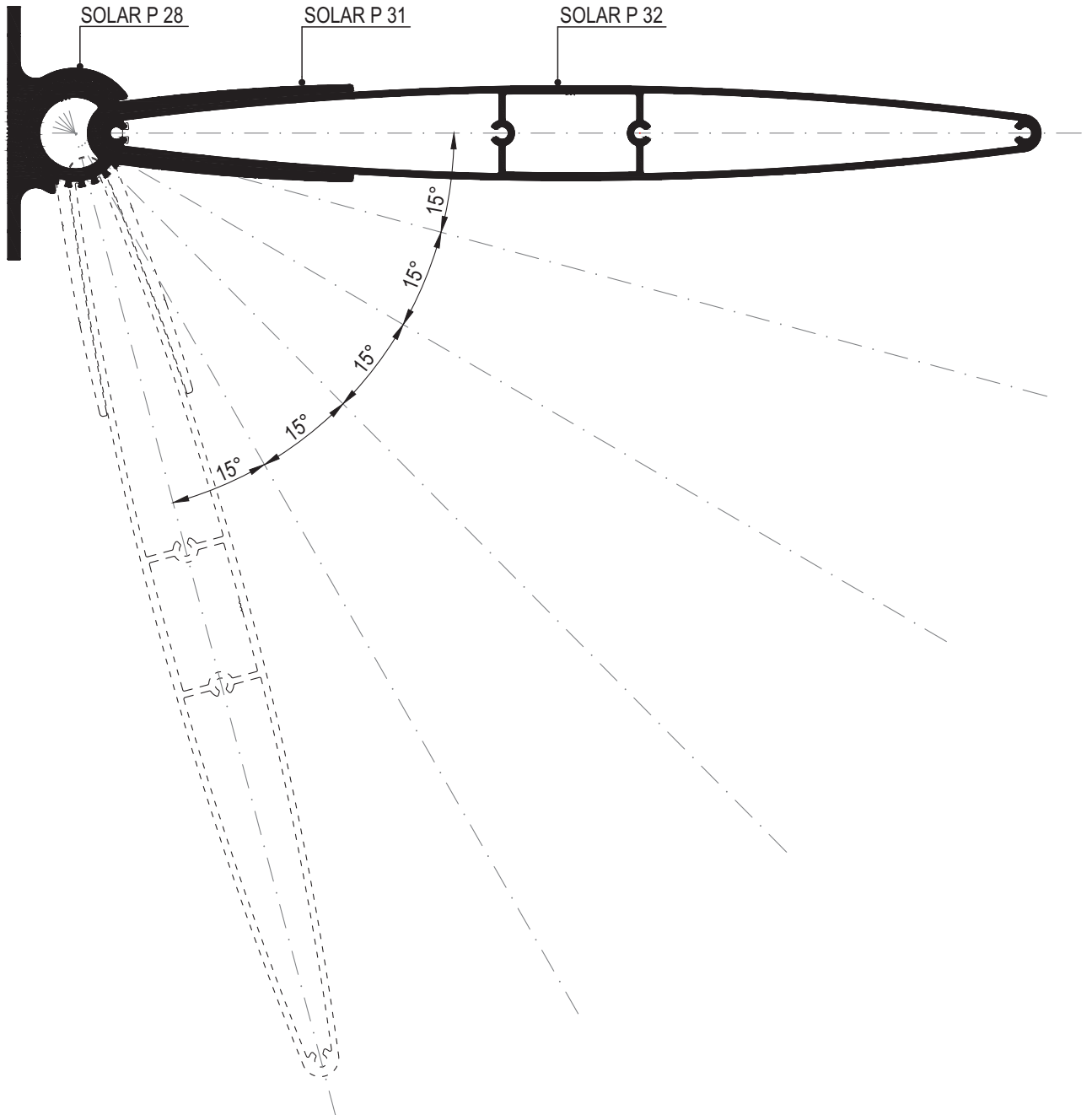

01

02

03

04

05

06

SOLAR P 35-36-37, SOLAR P 38, SOLAR P 39 İLE DETAY
DETAIL WITH SOLAR P 35-36-37, SOLAR P 31, SOLAR P 32

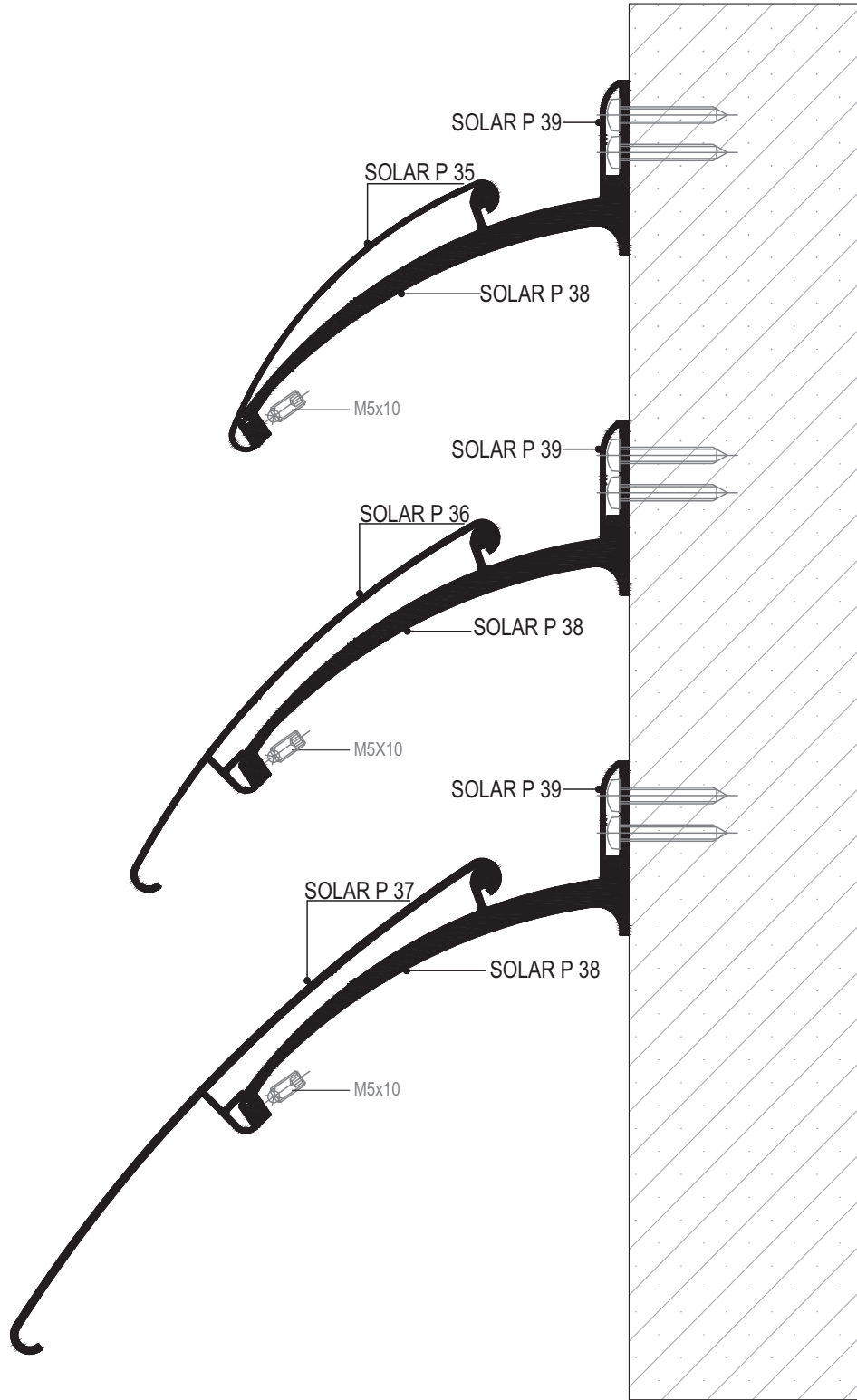

MİMARİ KATALOG ARCHITECTURAL CATALOGUE

Alüminyum Kapı Pencere ve Giydirme Cephe Sistemleri
Aluminium Window Doors and Facade Systems

RSS

AKSESUARLAR

ACCESSORIES

01











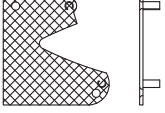
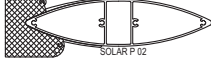



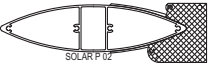

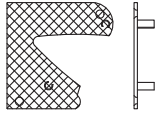
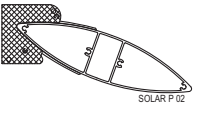
02

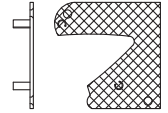
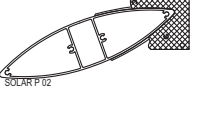
03

04

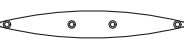
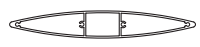
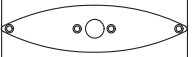
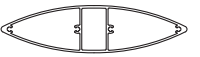
05

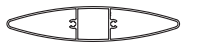
06

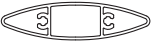
01	 <p>14.02.05 YAN KAPAK SOL CAP-LEFT Malzeme / Material: - PVC</p>	 <p>SOLAR P 13 (10827)</p>	 <p>14.02.09 YAN KAPAK CAP Malzeme / Material: - Alüminyum</p>	 <p>SOLAR P 16 (A006503)</p>
02	 <p>14.02.06 YAN KAPAK SAĞ CAP-RIGHT Malzeme / Material: - PVC</p>	 <p>SOLAR P 13 (10827)</p>	 <p>14.02.10 YAN KAPAK CAP Malzeme / Material: - Alüminyum</p>	 <p>SOLAR P 02 (A010683)</p>
03	 <p>14.02.07 YAN KAPAK SOL CAP-LEFT Malzeme / Material: - PVC</p>	 <p>SOLAR P 13 (10827)</p>	 <p>14.02.11 YAN KAPAK CAP Malzeme / Material: - Alüminyum</p>	 <p>SOLAR P 03 (A010684)</p>
04	 <p>14.02.08 YAN KAPAK SAĞ CAP-RIGHT Malzeme / Material: - PVC</p>	 <p>SOLAR P 13 (10827)</p>	 <p>14.02.12 YAN KAPAK CAP Malzeme / Material: - Alüminyum</p>	 <p>SOLAR P 24 (A011427)</p>
05	 <p>14.02.01 YAN KAPAK CAP Malzeme / Material: - Alüminyum</p>	 <p>SOLAR P 16 (A006503)</p>	 <p>14.02.13 YAN KAPAK CAP Malzeme / Material: - Alüminyum</p>	 <p>SOLAR P 34 (A011495)</p>
06	 <p>14.02.02 YAN KAPAK CAP Malzeme / Material: - Alüminyum</p>	 <p>SOLAR P 02 (A010683)</p>	 <p>14.02.14 YAN KAPAK CAP Malzeme / Material: - Alüminyum</p>	 <p>SOLAR P 19 (A011155)</p>
	 <p>14.02.03 YAN KAPAK CAP Malzeme / Material: - Alüminyum</p>	 <p>SOLAR P 03 (A010684)</p>		