

MİMARİ KATALOG

ARCHITECTURAL CATALOGUE

Alüminyum Kapı Pencere ve Giydirme Cephe Sistemleri

Aluminium Window Doors and Facade Systems

RD55

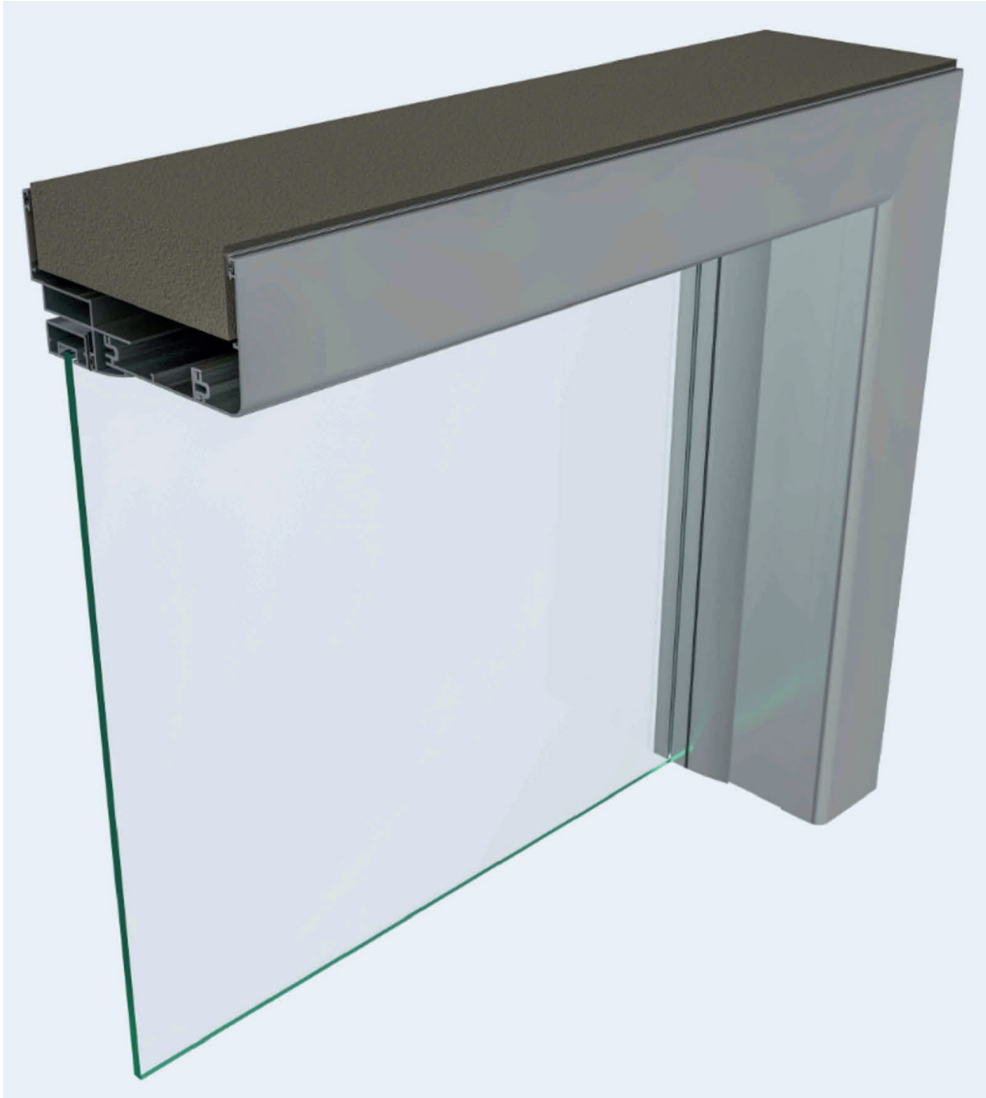

MİMARİ KATALOG

ARCHITECTURAL CATALOGUE

Alüminyum Kapı Pencere ve Giydirme Cephe Sistemleri
Aluminium Window Doors and Facade Systems

Rd55

PROFİLLER

PROFILES

01

02

03

04

05

06

07

08

09

10

11

12

13

KOD / CODE	AĞIRLIK (kg/m) / WEIGHT	Jxx cm ⁴	Jyy cm ⁴	L m	
RD55 F 01	1,373	25,243	38,509	6	
RD55 F 02	1,500	25,765	48,453	6	

RD55 F 01

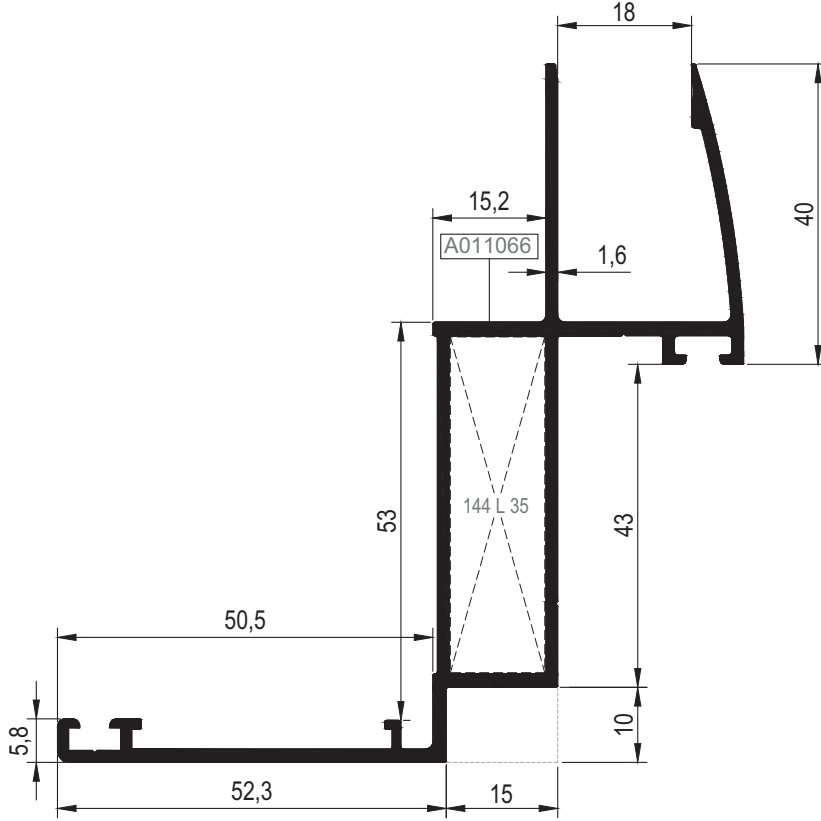

RD55 F 02

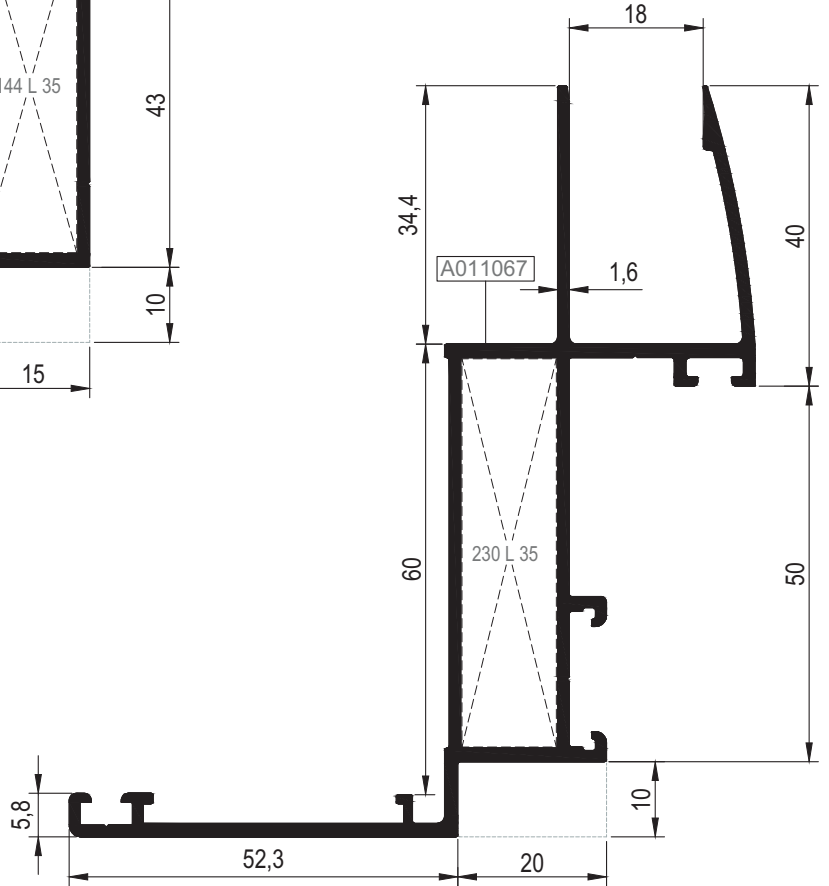

Nr		L m	KESİM ÖLÇÜSÜ CUTTING SIZE	AKS. KODU ACS. CODE
RD55 F 01	A011066	25 L 35 (A010076)	44,4 mm	144 L 35
RD55 F 02	A011067	25 L 35 (A010076)	51,4 mm	230 L 35

KOD / CODE	AĞIRLIK (kg/m) / WEIGHT	Jxx cm ⁴	Jyy cm ⁴	L m	
RD55 V 02	0,688	1,267	4,539	6	
RD55 A 01	0,860	----	----	6	
RD55 A 02	0,977	----	----	6	

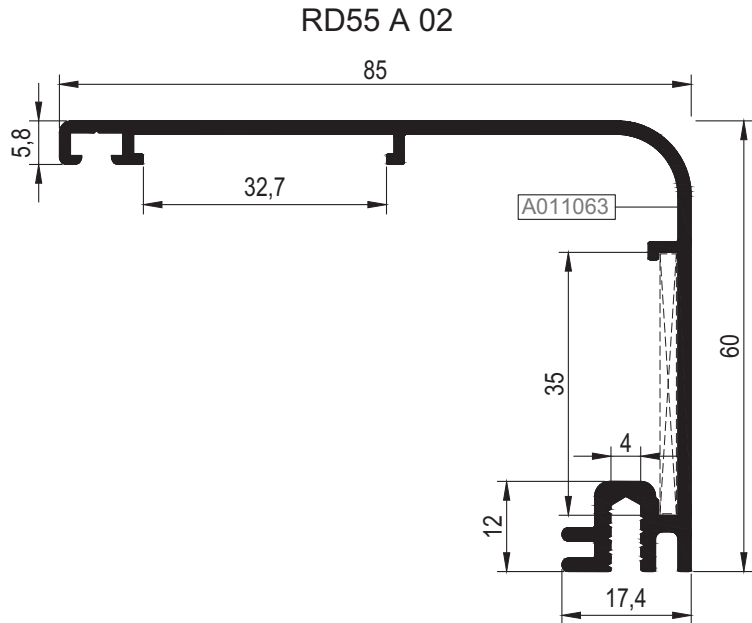
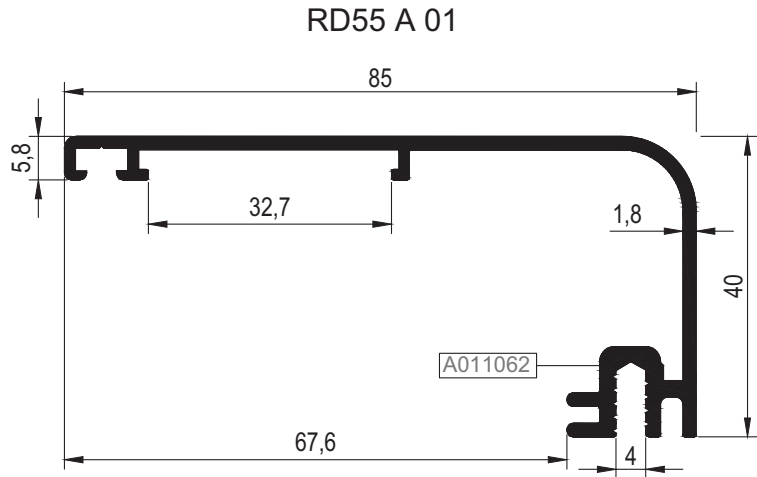
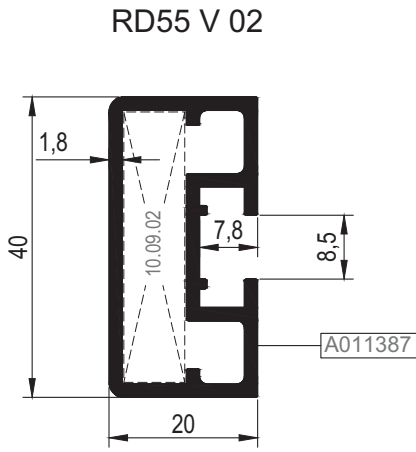

Nr		L m	KEŞİM ÖLÇÜSÜ CUTTING SIZE	AKS.KODU ACS.CODE
RD55 A 02	A011063	25 L 71 (A011071)	34,6 mm	250 L 71

KOD / CODE	AĞIRLIK (kg/m) / WEIGHT	Jxx cm ⁴	Jyy cm ⁴	L m
RD55 A 03	1,154	----	----	6
RD55 A 04	1,376	----	----	6
RD55 A 05	0,771	----	----	6

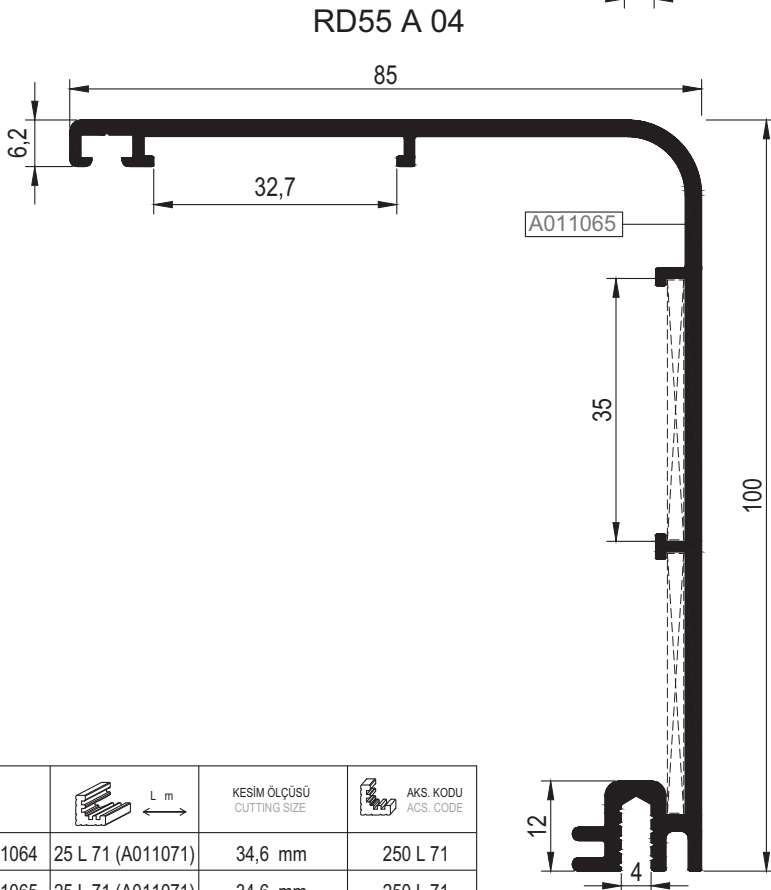
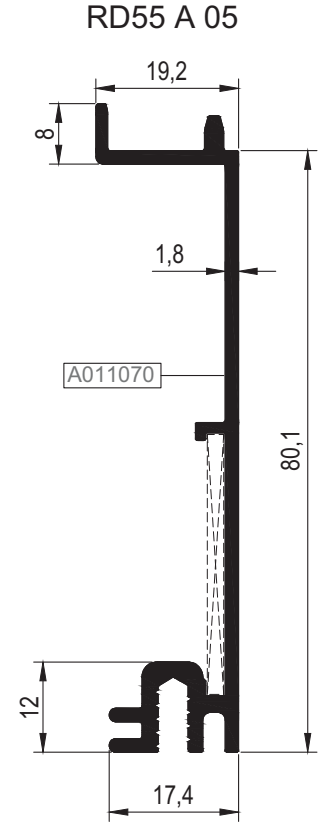
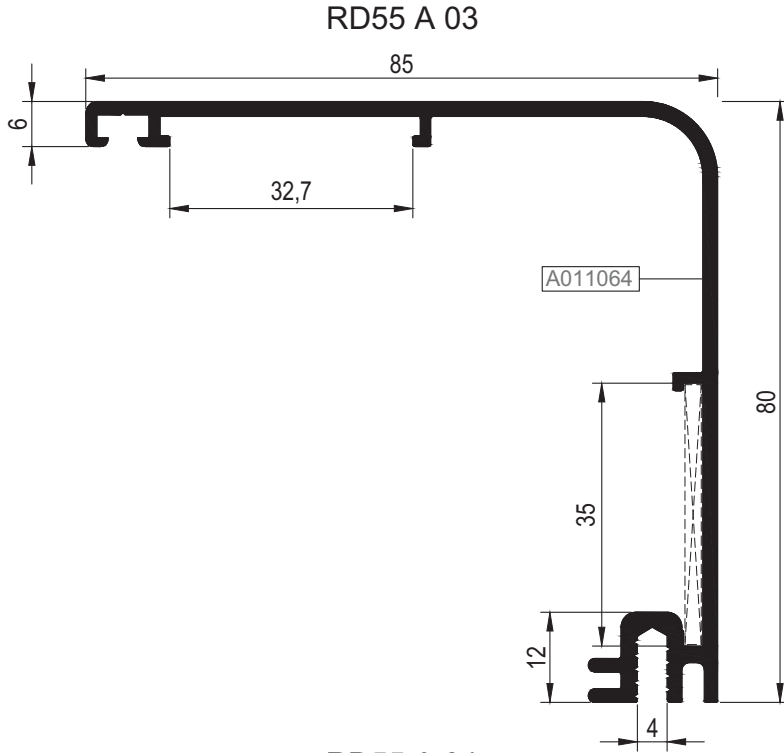
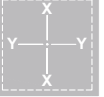

Nr	 L m	KESİM ÖLÇÜSÜ CUTTING SIZE	AKS. KODU ACS. CODE
RD55 A 03	A011064 25 L 71 (A011071)	34,6 mm	250 L 71
RD55 A 04	A011065 25 L 71 (A011071)	34,6 mm	250 L 71
RD55 A 05	A011070 25 L 71 (A011071)	34,6 mm	250 L 71

KOD / CODE	AĞIRLIK (kg/m) / WEIGHT	Jxx cm ⁴	Jyy cm ⁴	L m
RD55 A 06	1,312	----	----	6
RD55 A 07	1,410	----	----	6
RD55 A 08	1,641	----	----	6
RD55 A 09	1,749	----	----	6

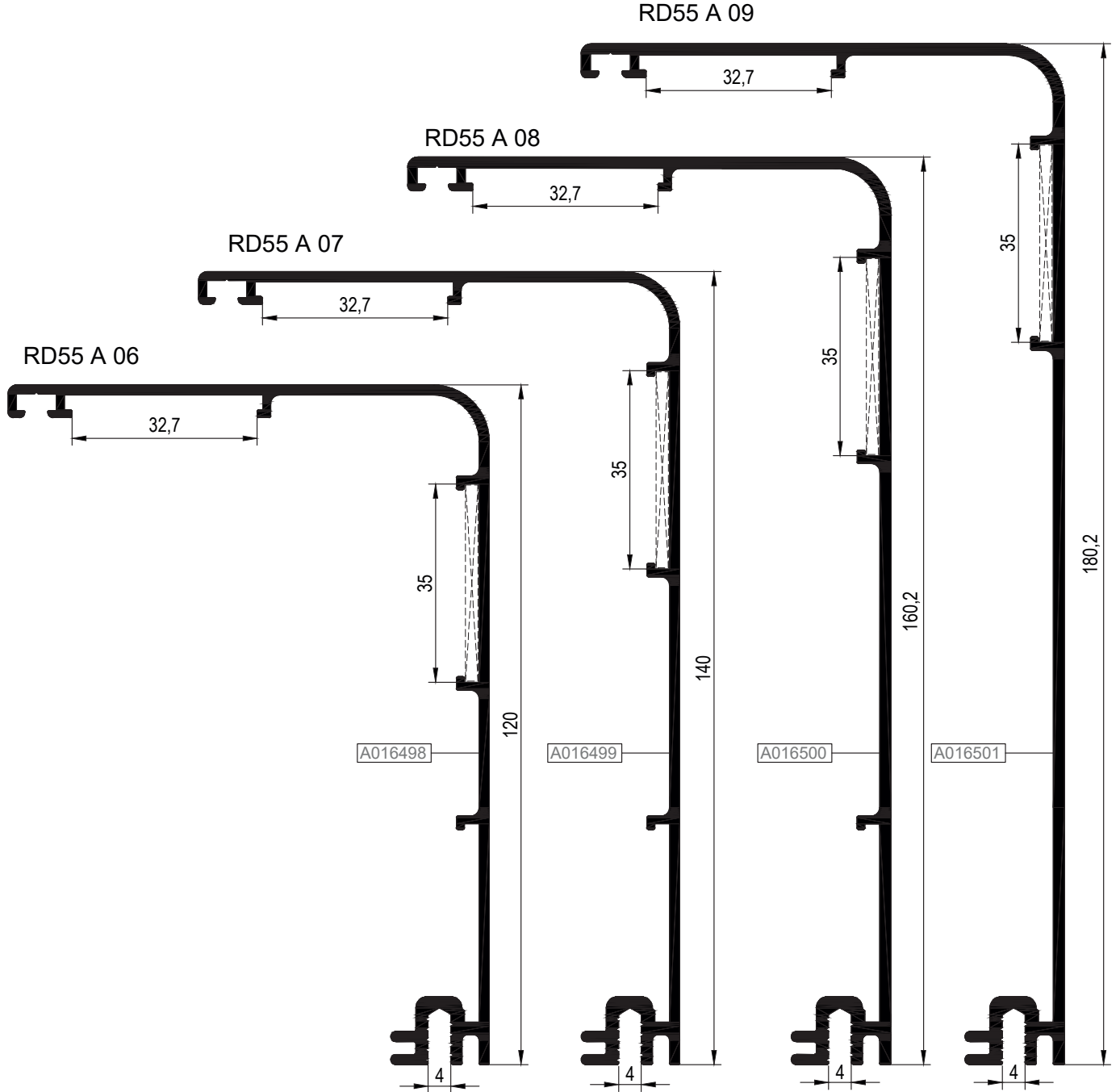
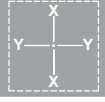

Nr		L m	KESİM ÖLÇÜSÜ CUTTING SIZE	AKS. KODU ACS. CODE
RD55 A 06	A016498	25 L 71 (A011071)	34,6 mm	250 L 71
RD55 A 07	A016499	25 L 71 (A011071)	34,6 mm	250 L 71
RD55 A 08	A016500	25 L 71 (A011071)	34,6 mm	250 L 71
RD55 A 09	A016501	25 L 71 (A011071)	34,6 mm	250 L 71

01

TAKOZLAR (CLEATS)

02

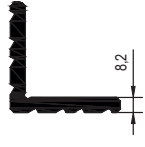
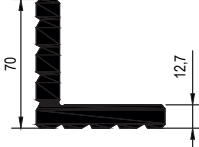
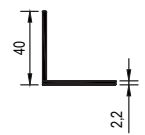
PROFİL KODU (PROFILE CODE)	25 L 18	25 L 35	25 L 71	
FABRİKA KODU (FACTORY CODE)	A002164	A010076	A011071	
AĞIRLIK (WEIGHT)	2,323 kg/m	4,192 kg/m	0,464 kg/m	
ÇİZİM (DRAWING)				

03

04

KÖŞE TAKOZLARI (CORNER CLEATS)

Nr	 L m	KESİM ÖLÇÜSÜ CUTTING SIZE	AKS. KODU ACS. CODE
RD55 F 01	A011066 25 L 35 (A010076)	44,4 mm	144 L 35
RD55 F 02	A011067 25 L 35 (A010076)	51,4 mm	230 L 35
RD55 V 02	A011387 25 L 18 (A002164)	35,9 mm	111 L 18
RD55 A 02	A011063 25 L 71 (A011071)	34,6 mm	250 L 71
RD55 A 03	A011064 25 L 71 (A011071)	34,6 mm	250 L 71
RD55 A 04	A011065 25 L 71 (A011071)	34,6 mm	250 L 71
RD55 A 05	A011070 25 L 71 (A011071)	34,6 mm	250 L 71



05

06

07

STOKTA BULUNAN SİSTEM PROFİLLERİNİN LİSTESİ (LIST OF SYSTEM PROFILES IN STOCK)

08

Nr	MIN. SİPARİŞ MİKTARI MIN. ORDER QUANTITY
RD55 V 02	A011387 75 kg
RD55 A 04	A011065 75 kg
RD55 A 05	A011070 75 kg

09

* STOKTA BULUNMAYAN TÜM YALITIMLI VE YALITIMSIZ PROFİLLER İÇİN MİNİMUM SİPARİŞ MİKTARI 300 KG'DIR.
MINIMUM ORDER QUANTITY FOR ALL THE PROFILES THAT ARE NOT IN STOCK IS 300 KG.

10

11

12

13

MİMARİ KATALOG

ARCHITECTURAL CATALOGUE

Alüminyum Kapı Pencere ve Giydirme Cephe Sistemleri
Aluminium Window Doors and Facade Systems

Rd55

DETAYLAR

DETAILS

01

02

03

04

05

06

07

08

09

10

11

12

13

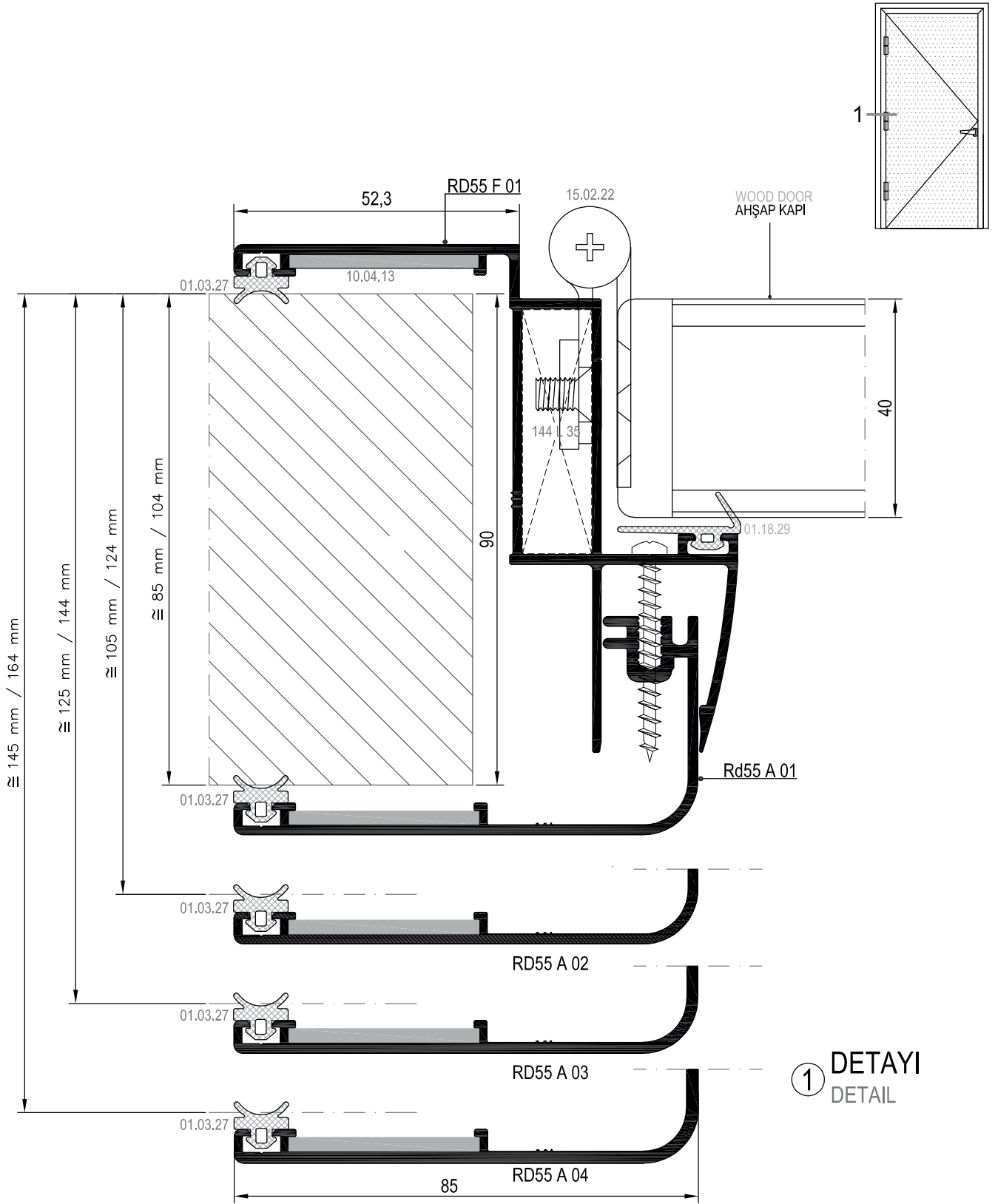

1 DETAYI
DETAIL

DUVAR KALINLIĞI WALL THICKNESS	KASA PROFİLİ FRAME PROFILE	PERVAZ PROFİLİ SILL PROFILE	ADAPTÖR PROFİLİ ADAPTER PROFILE
85 mm~104 mm	Rd55 F 01	+ Rd55 A 01	+ ---
105 mm~124 mm	Rd55 F 01	+ Rd55 A 02	+ ---
125 mm~144 mm	Rd55 F 01	+ Rd55 A 03	+ ---
145 mm~164 mm	Rd55 F 01	+ Rd55 A 04	+ ---

DUVAR KALINLIĞI WALL THICKNESS	KASA PROFİLİ FRAME PROFILE	PERVAZ PROFİLİ SILL PROFILE	ADAPTÖR PROFİLİ ADAPTER PROFILE
165 mm~184 mm	Rd55 F 01	+ Rd55 A 01	+ Rd55 A 05
185 mm~204 mm	Rd55 F 01	+ Rd55 A 02	+ Rd55 A 05
205 mm~224 mm	Rd55 F 01	+ Rd55 A 03	+ Rd55 A 05
225 mm~244 mm	Rd55 F 01	+ Rd55 A 04	+ Rd55 A 05

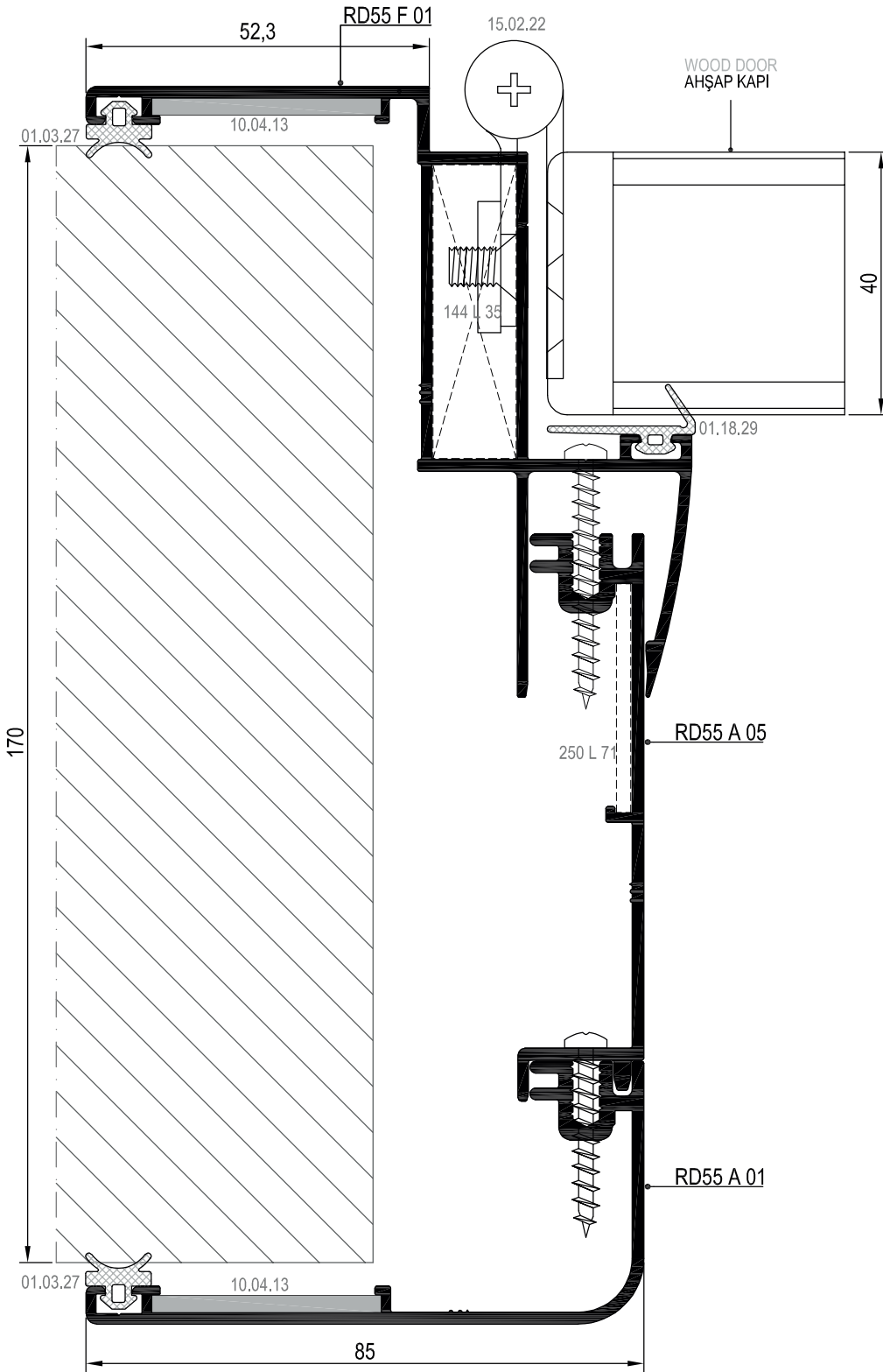

② DETAYI
DETAIL

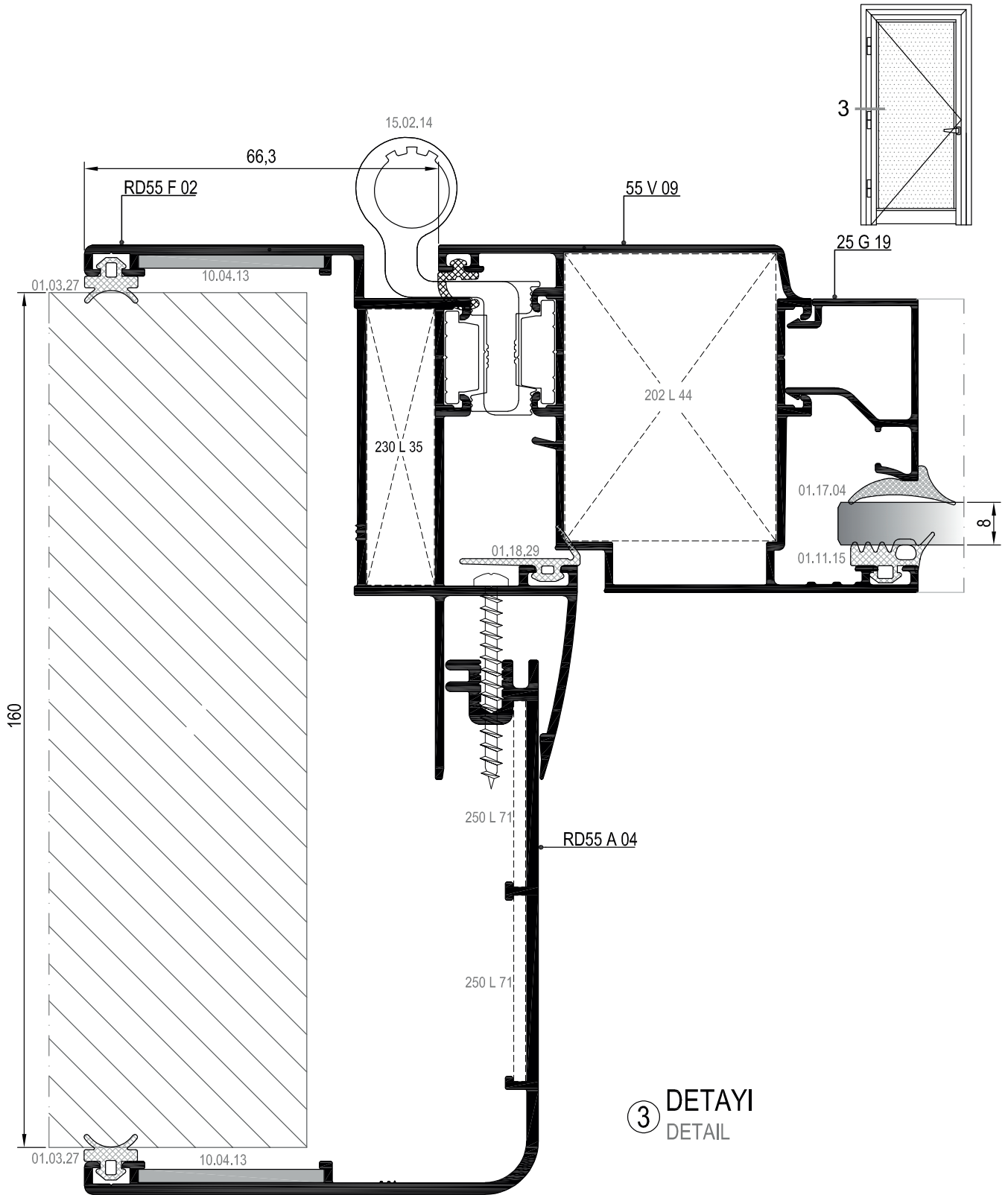

③ DETAYI
DETAIL

DUVAR KALINLIĞI WALL THICKNESS	KASA PROFİLİ FRAME PROFILE	PERVAZ PROFİLİ SILL PROFILE	ADAPTÖR PROFİLİ ADAPTER PROFILE
90 mm~109 mm	Rd55 F 02	+ Rd55 A 01	+
110 mm~129 mm	Rd55 F 02	+ Rd55 A 02	+
130 mm~149 mm	Rd55 F 02	+ Rd55 A 03	+
150 mm~169 mm	Rd55 F 02	+ Rd55 A 04	+

DUVAR KALINLIĞI WALL THICKNESS	KASA PROFİLİ FRAME PROFILE	PERVAZ PROFİLİ SILL PROFILE	ADAPTÖR PROFİLİ ADAPTER PROFILE
170 mm~185 mm	Rd55 F 02	+ Rd55 A 01	+ Rd55 A 05
189 mm~209 mm	Rd55 F 02	+ Rd55 A 02	+ Rd55 A 05
210 mm~229 mm	Rd55 F 02	+ Rd55 A 03	+ Rd55 A 05
230 mm~249 mm	Rd55 F 02	+ Rd55 A 04	+ Rd55 A 05

01

02

03

04

05

06

07

08

09

10

11

12

13

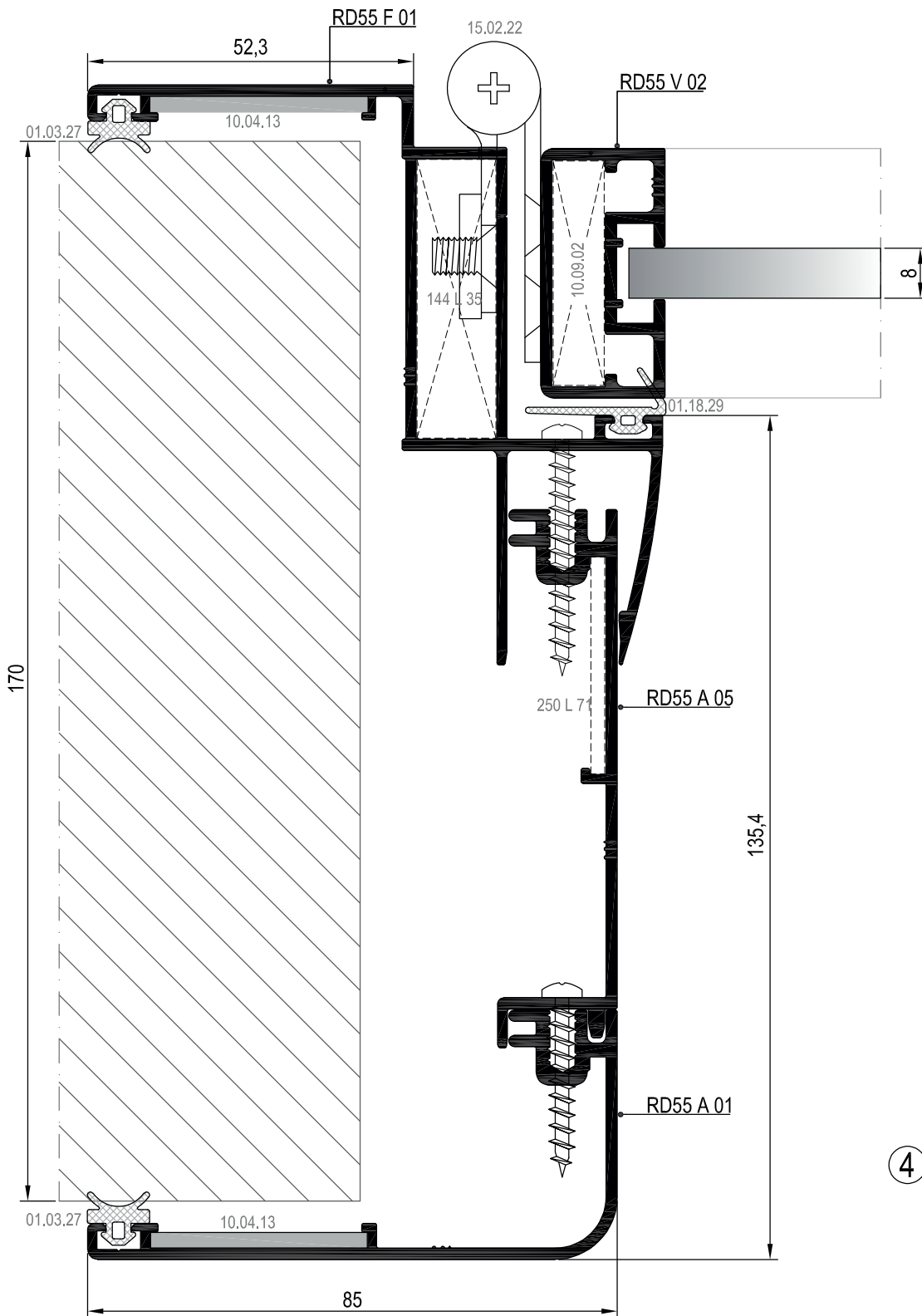
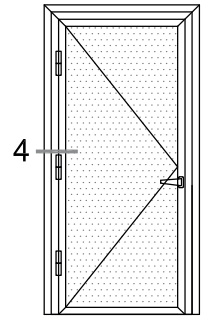

④ DETAYI
DETAIL

01

02

03

04

05

06

07

08

09

10

11

12

13

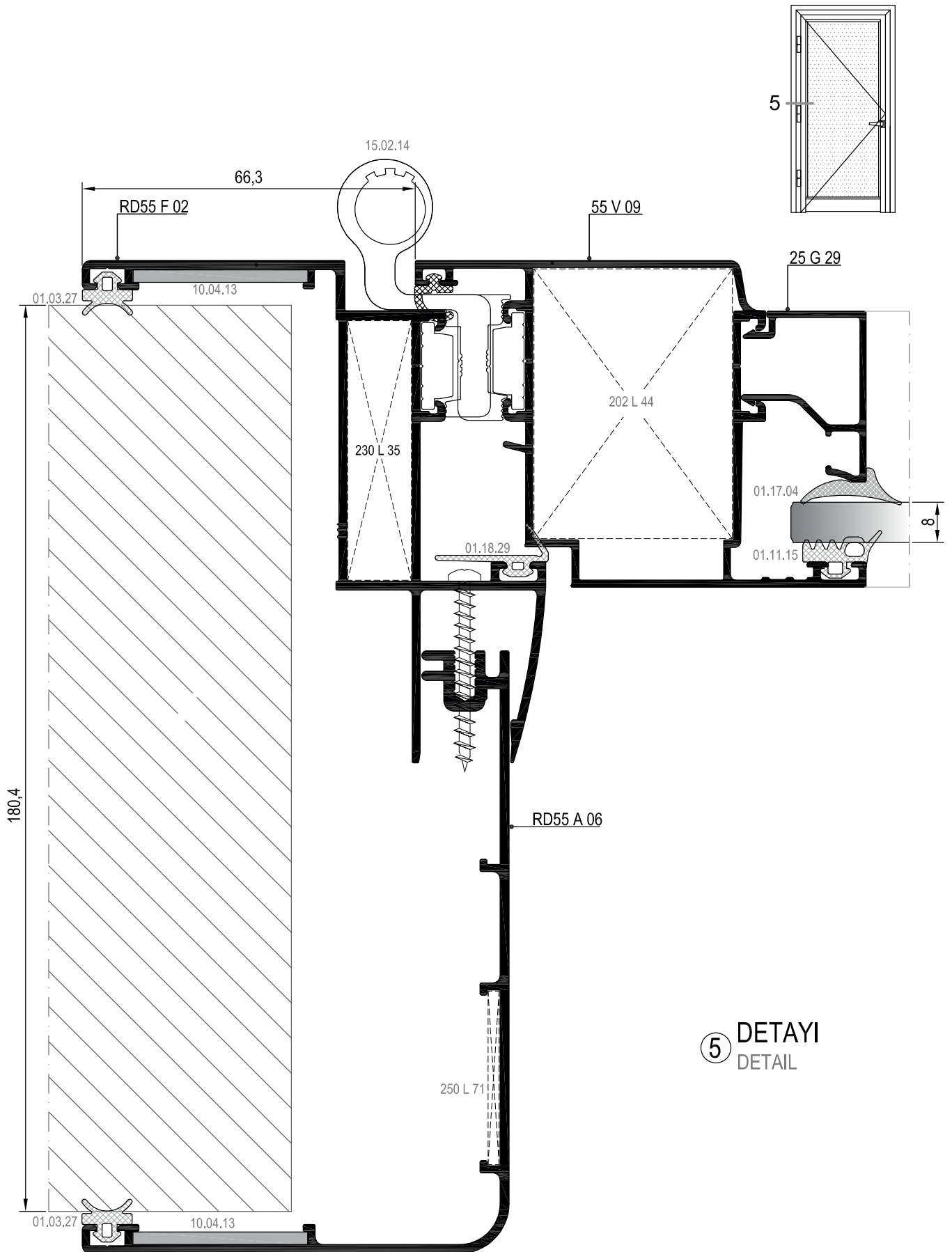

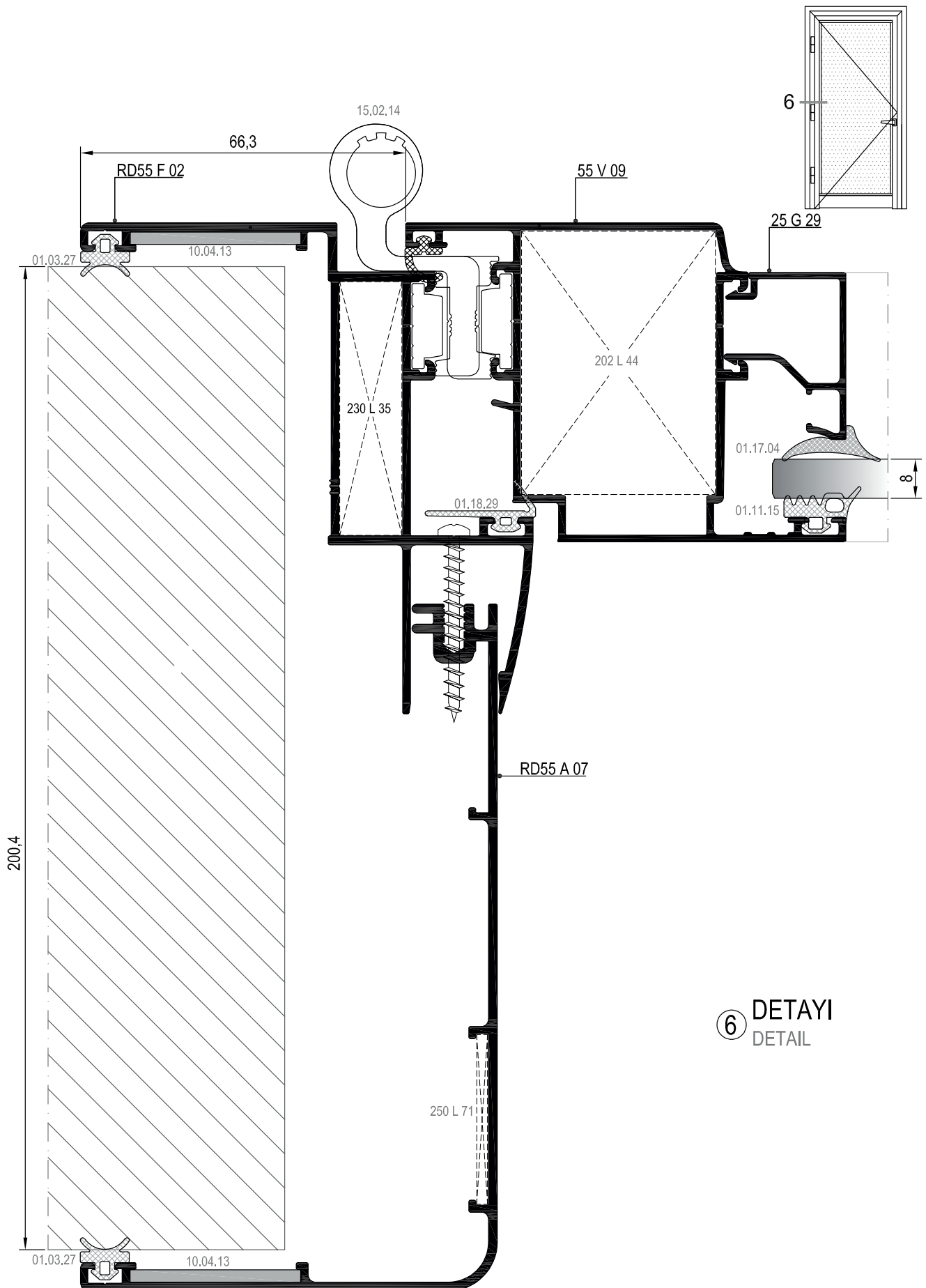

01

02

03

04

05

06

07

08

09

10

11

12

13

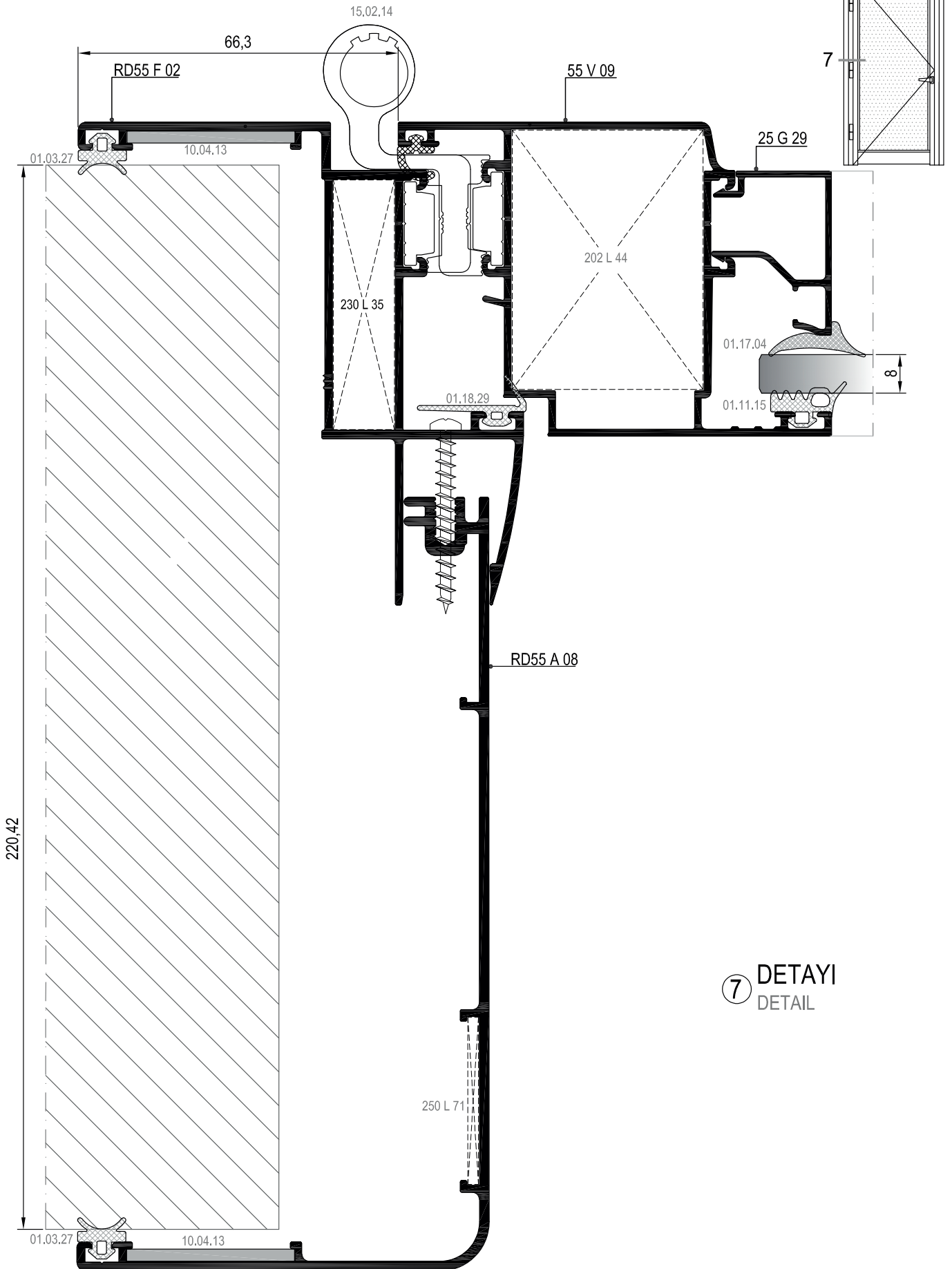

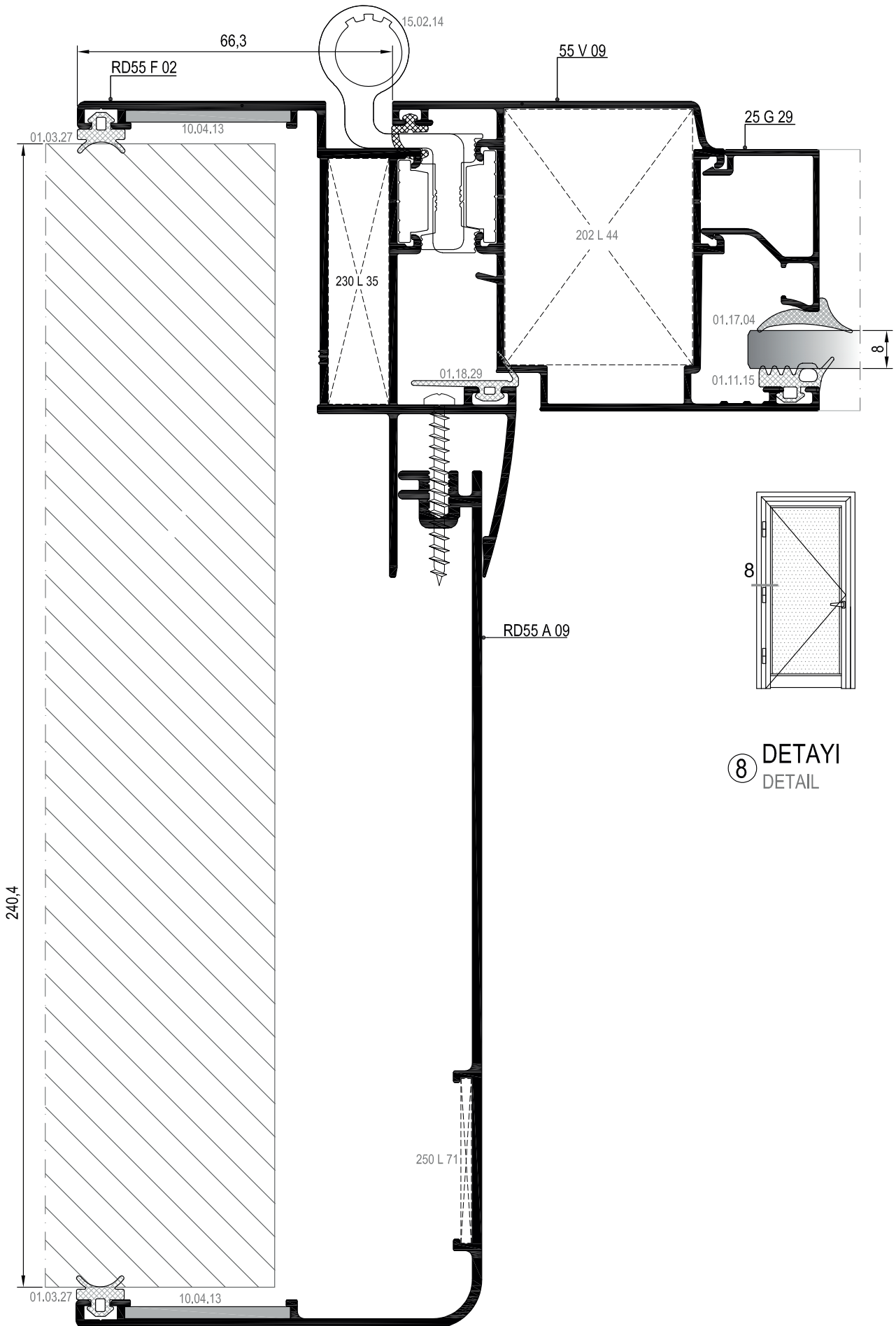

MİMARİ KATALOG

ARCHITECTURAL CATALOGUE

Alüminyum Kapı Pencere ve Giydirme Cephe Sistemleri
Aluminium Window Doors and Facade Systems

Rd55

AKSESUARLAR

ACCESSORIES

01

02

03

04

05

06

07

08

09

10

11

12

13

01

02

03

04

05

06

07

08







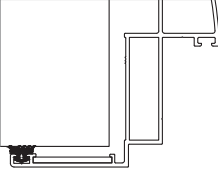

09

10

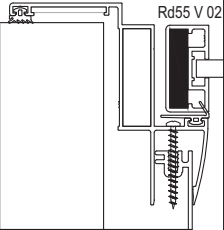
11

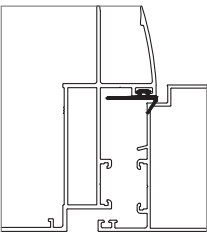
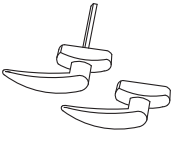
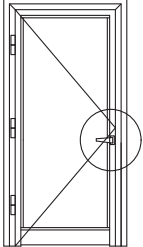
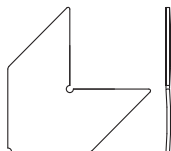
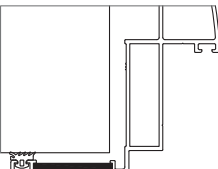
12

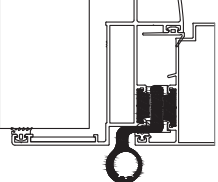
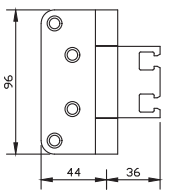
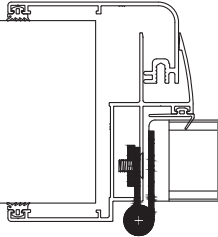
13

	<p>01.03.07</p> <p>BİNİ FİTİLİ ACOUSTICAL GASKET</p> <p>Malzeme / Material : EPDM Ağırlık / Weight : 55 gr/m Paket / Package: 270m / 15 kg</p>			<p>10.09.02</p> <p>KÖŞE BAĞLANTI CORNER CONNECTION PIECE</p>	
	<p>01.18.29</p> <p>BİNİ FİTİLİ ACOUSTICAL GASKET</p> <p>Malzeme / Material : EPDM Ağırlık / Weight : 64 gr/m Paket / Package: 234 m / 15 kg</p>				
	<p>07.14.04</p> <p>KAPI KOLU DOOR HANDLE</p> <p>Malzeme / Material : - Renk: Siyah-Beyaz-Gri Color: Black-White-Grey</p>				
	<p>10.04.13</p> <p>KÖŞE ÇAVUŞU CORNER PIECE</p> <p>Malzeme: Paslanmaz Çelik Material : Stainless Steel</p>				
	<p>15.02.09</p> <p>YERLİ KAPI MENTEŞESİ LOCAL HINGE FOR DOORS</p> <p>Renk: Siyah-Beyaz-Gri-Eloksal Color: Black-White-Grey-Anodised</p> <p>85kg için 3adet kullanılmalıdır./Should be used 3 for 85kg. Max.kanat ölçüsü 900x2200./Max.vent dimension 900x2200</p>	<p>55 V 09</p> 			
	<p>15.02.10</p> <p>KAPI MENTEŞESİ DOOR HINGE</p> <p>Renk: Siyah-Beyaz-Gri-Eloksal Color: Black-White-Grey-Anodised</p>				
	<p>15.02.14</p> <p>GIESSE KAPI MENTEŞESİ GIESSE HINGE FOR DOORS</p> <p>Renk: Siyah-Beyaz-Gri-Eloksal Color: Black-White-Grey-Anodised</p> <p>100kg için 2adet, 120kg için 3adet kullanılmalıdır./Should be used 2for 100kg, 3for 120kg. EN 1935</p>	<p>55 V 09</p> 